



NB-IoT Pulse Counter

VEGA NB-11

User manual



Document Information

Title	Pulse Counter Vega SI-11
Document type	Manual – Translation from Russian
Document number	V02-NB11-01
Revision and date	04 - 02 March 2021

This document applies to the following products:

Product name	Type number
Vega NB	Vega NB-11

Revision History

Revision	Date	Name	Comments
01	17.06.2019	KEV	The first release
02	14.07.2020	KEV	Minor changes
03	08.10.2020	KEV	We recalculate the number of transmitted packets in warranty conditions
04	02.03.2021	KEV	New parts " Pulse inputs settings ", " Mounting recommendations ", we replace configurator screenshots, new function of the pulse filtering

CONTENTS

INTRODUCTION	4
1 DESCRIPTION AND OPERATION	5
Device description	5
Communication and data collection algorithm	5
Functional	6
Marking	6
2 SPECIFICATION	7
3 OPERATION.....	8
Contacts	8
Pulse inputs settings	8
Hall sensor	10
Buttons	11
Indication	12
Initial Startup	13
Mounting recommendations	13
Connecting via USB	14
4 VEGA NB-IoT CONFIGURATOR	16
Interface of the application	16
Connection to the device	17
"System" tab	18
"Settings" tab	19
"Vega NB-11" tab	21
5 COMMUNICATION PROTOCOL	22
6 STORAGE AND TRANSPORTATION REQUIREMENTS	24
7 CONTENT OF THE PACKAGE	25
8 WARRANTY.....	26

INTRODUCTION

This manual is designated for Vega NB-11 pulse counter (hereinafter – the counter) manufactured by Vega-Absolute OOO and provides information on powering and activation procedure, control commands and functions of the counter.

This manual is targeted at specialists familiar with installation work fundamentals of electronic and electrical equipment.



The counter shall be installed and adjusted by qualified specialists to ensure proper operation of the device

Vega-Absolute OOO reserves the right to make changes to the manual related to the improvement of equipment and software, as well as to eliminate typos and inaccuracies, without prior notice.

1 DESCRIPTION AND OPERATION

DEVICE DESCRIPTION

Vega NB-11 pulse counter is designed for counting of pulses incoming to 4 independent inputs, further accumulating and transmitting of this information in NB-IoT network.

In addition, Vega NB-11 can be used as a security device – two additional inputs operate in security mode, there is also Hall sensor.

The pulse counter can be used for any utilities' meters and industrial equipment with pulse output of herkon type or open-drain type.



Equipment with NAMUR pulse output is not supported

De-bouncing logics is integrated in the pulse counter. The pulse counting is carried out for frequencies up to 200 Hz.

The counter is powered by a 6400 mAh built-in battery.

COMUNICATION AND DATA COLLECTION ALGORITHM

The readings collecting from the meter with a configurable period 5, 15, 30 minutes, 1, 2, 3, 4, 6, 12 or 24 hours. The readings stored in the device memory and transmitting during the next communication session with the NB-IoT network.

The adjustable data transfer period can be equal to 5, 15, 30 minutes, 1, 2, 3, 4, 6, 12 and 24 hours. Data transferring in random point in time during set period. At the next communication session, the device starts sending accumulated packets with readings, from the earliest to the latest.

The device operates with confirmation all the time and send the next packet only after receiving a confirmation of the delivery of the previous one. If such confirmation was not received, NB-11 completes the communication session until the next one according to the schedule. Herewith, the device continues to collect data according to the data collection period and store it in memory. Non-transmitted packets remain in the device memory until the next communication session.

The internal clock is set automatically when device connected to the "Vega NB-IoT Configurator" via USB.

FUNCTIONAL

Vega NB-11 pulse counter has the following features:

- Four pulse inputs for connecting the external devices with pulse output
- Two inputs operating in the «security» mode for connecting the external leakage and safety sensors, etc.
- Queue of sending when delivery is not possible
- Time referencing of readings by internal clock
- Communication in case of security inputs or Hall sensor actuation
- Temperature measurement
- Charge measuring of the built-in battery (%)
- Ability to filter the pulses by the duration

MARKING

Device marked with sticker that contain the next information:

- Device model;
- IMEI;
- Month and year of manufacture;
- QR-code containing IMEI for automatized count.

Sticker located in three places – on device case, in factory certificate and on the packing box.

2 SPECIFICATION

Main

Pulse inputs	4
Maximum input frequency	200 Hz
Security inputs	2
USB-port	micro-USB, type B
Operating temperatures	-40...+85 °C
Built-in temperature sensor	yes
Hall sensor	yes
Quantity of black box records	up to 100 000

Cellular communications

Supported Cellular Standards	LTE Cat NB1
Data transfer protocol	MQTT
Guaranteed number of transmitted packets if the data transferring once a day	3600
LTE NB-IoT antenna type	external

Power

Built-in battery	6400 mAh
------------------	----------

Case

Housing dimensions	95 x 95 x 50 mm
Ingress protection rating	IP67

3 OPERATION

CONTACTS

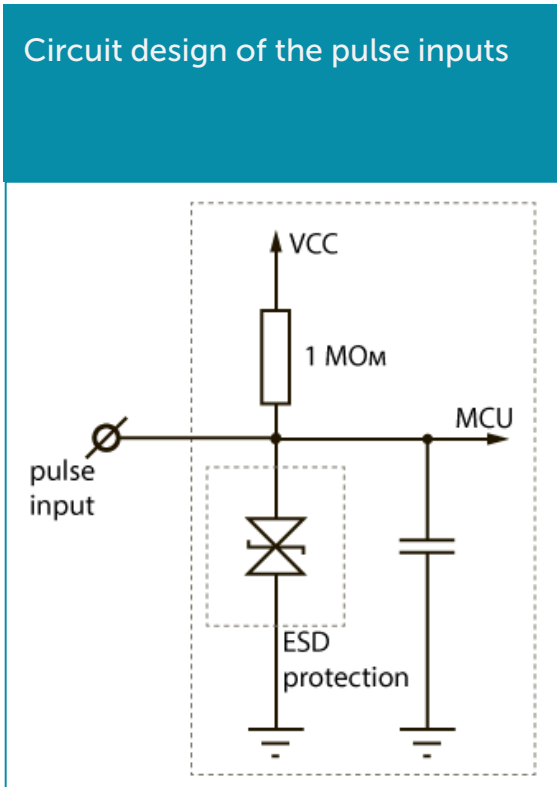
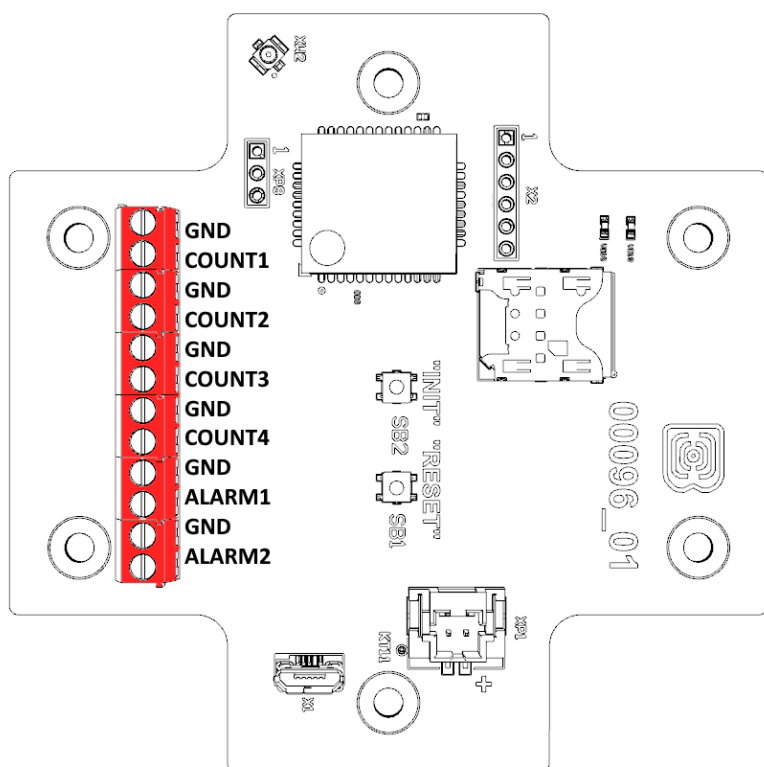

The pulse counter allows to connect circuits with the following types of NO contacts:

- reed switch;
- mechanical pushbutton;
- open-collector output.



Equipment with NAMUR pulse output is not supported

Polarity effects only "open collector" circuits.

There are two security inputs on the board. The device monitors status changes on the security inputs and when the security input triggers, the device is activated and sends an alarm message to the network.

PULSE INPUTS SETTINGS

When you connect the modem to metering devices with a pulse output, it is necessary to consider the features of the pulse of a specific type of metering device: bounce, minimum pulse and pause duration. To do this, it is necessary to record the characteristics of the pulse with an oscilloscope or obtain information from the manufacturer of the meter.

The modem has a special software pulse filter. The filter is represented by two settings for each pulse input (see section 4, "Settings" tab). Consider the features of filtering settings for different pulse outputs.

1) Mechanical pulse output

Usually, the mechanical pulse output in metering devices is implemented on a reed switch, but it can also be a button or other mechanics. The main problem with such outputs is contact bounce. At a moment of falling and rising, there are many additional impulses that need to be no considered in the calculation. In addition, the pulse duration floats and depends on the current flow rate of the meter. For correct counting, it is necessary to determine the minimum useful pulse duration and the minimum pause between useful pulses (all that is less is bounce). The obtained values must be set in the modem settings.

The minimum useful pulse duration is the pulse duration that the meter produces at the maximum flow rate (the maximum flow rate is indicated in the meter's passport). This duration does not include bounce time. The minimum pause duration can be set equal to the minimum pulse width, or longer if necessary. Usually, the pause between pulses is an order of magnitude higher.

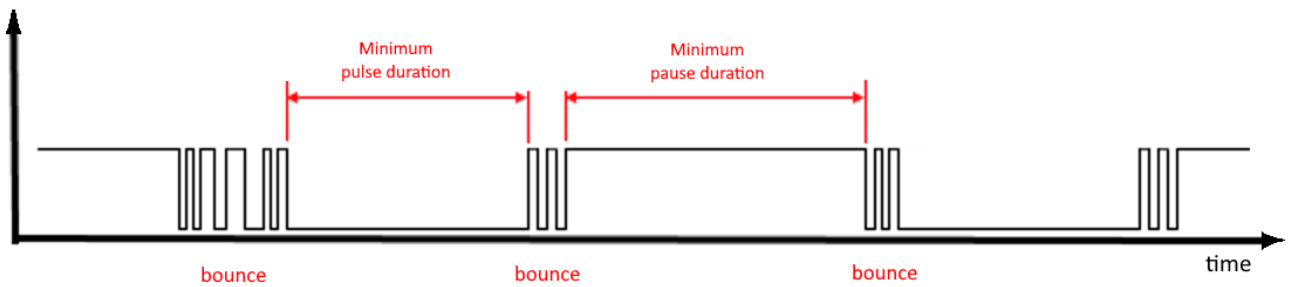

2) 2) Electronic pulse output

The electronic pulse output has no bounce (open collector output). This output usually has a fixed pulse width. For the modem to fix the pulse, it is necessary to set in the settings the minimum pulse duration less than the actual pulse duration issued by the meter.

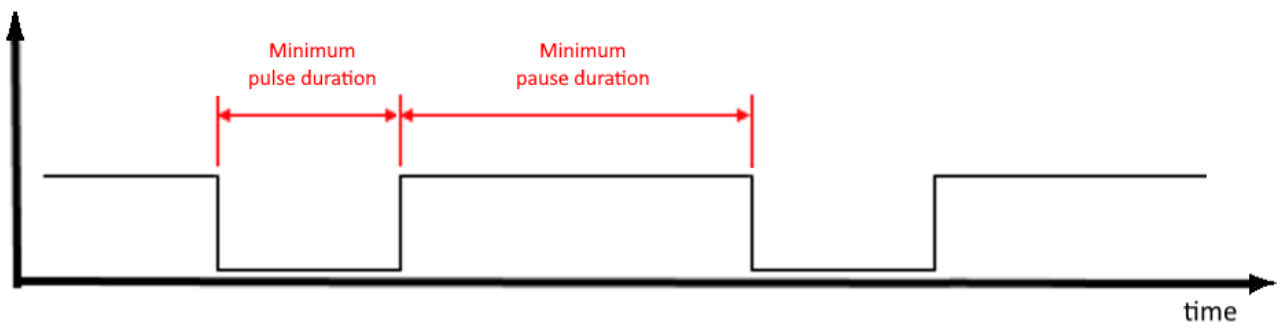

HALL SENSOR

The device has Hall sensor which located on the board edge on the bottom side. When the magnet is brought up the sensor triggered, and the device can form the alarm message which immediately transmitted to the server.

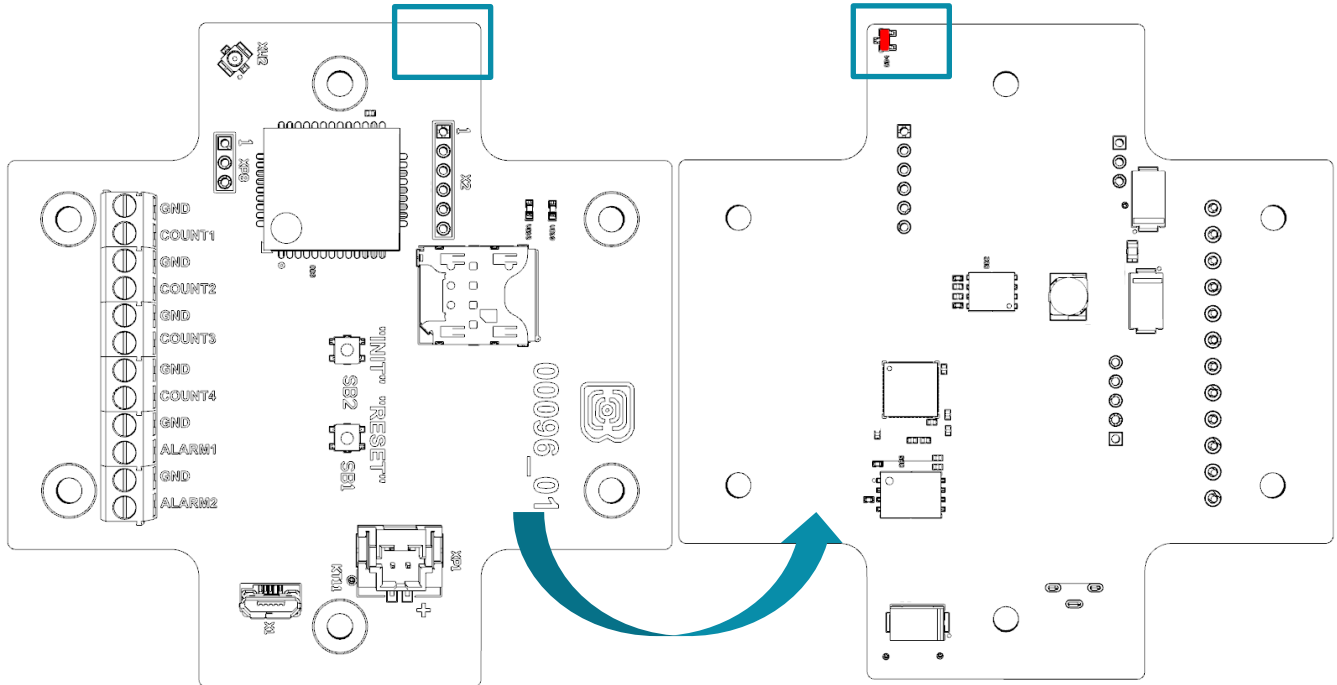

BUTTONS

There are two buttons on the board which can help you to manage the device. Buttons are described in the table below.

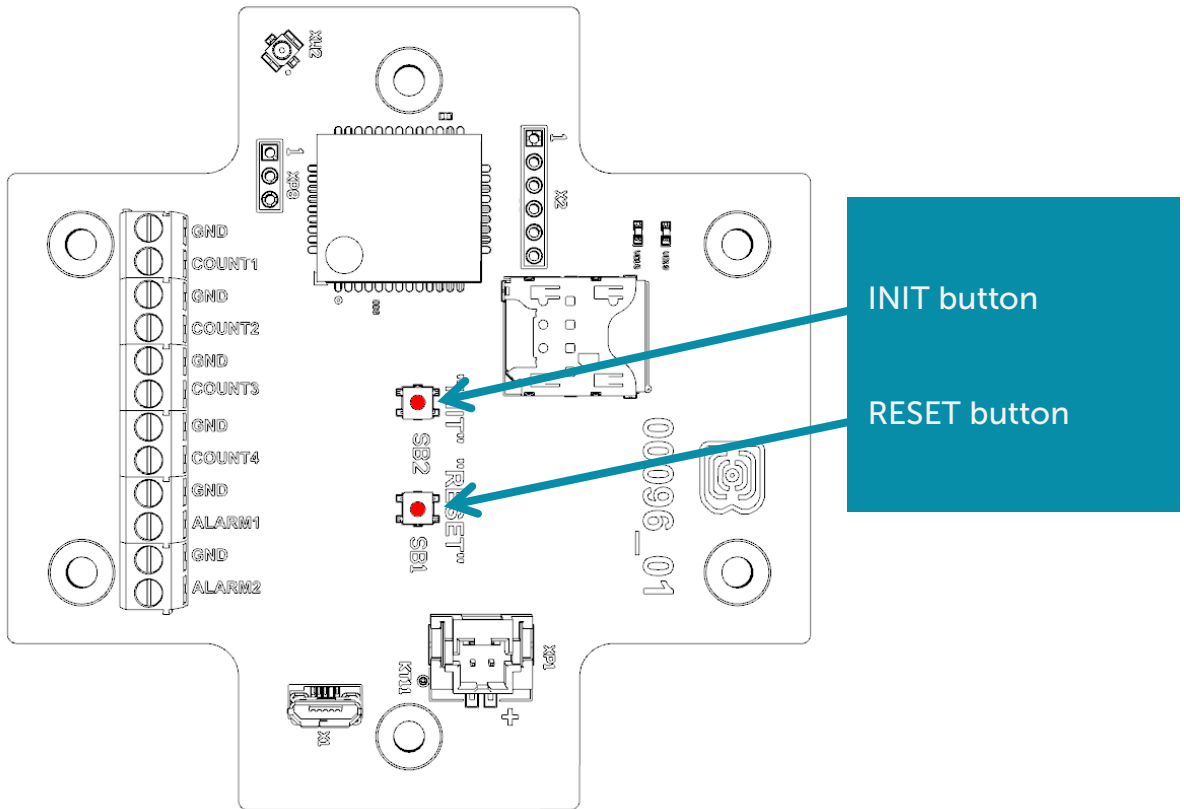

Action	Result
RESET	
Short pressing	Device reloading
INIT	
Pressing for 1 second	Registration at the network
Pressing for 2 seconds	Data transmitting
Pressing for 3 seconds	LTE-modem switching off
Pressing for 4 seconds	To form record to the black box





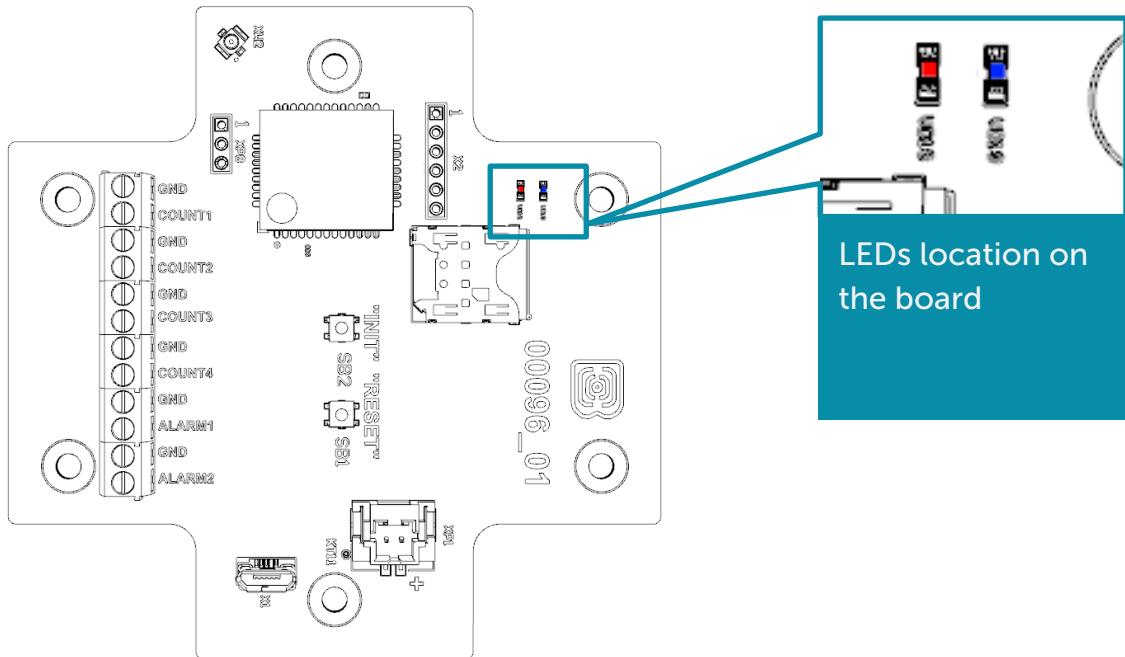

When you hold down the button, the red LED starts flashing once a second, which will help you to find out the duration of pressing. Pressing for 1 second corresponds to one flash of the LED, pressing for 2 seconds corresponds to two and so on.

INDICATION

There are two LEDs on the board: red and blue. Blue LED VD19 shows LTE-modem state, and red LED VD18 – the device state.



LEDs location on the board

LED signal	Meaning
LTE-modem	
	Short flash every three seconds Device searches the network
	Short flash every second Device is successfully registered, and it is in the network
	Two short flashes every one second Device transmits data to the network
	No light LTE-modem is switched off
Device	
	Short flash every second Battery charge is lower than 5%
	Short flash every five seconds Device is in the 'Operation' mode
	No light Device is in the 'Sleep' mode or switched off

INITIAL STARTUP

Firstly, it is necessary to install SIM into slot on the board and set up the data transmitting with “Vega NB-IoT Configurator” (See part 4).

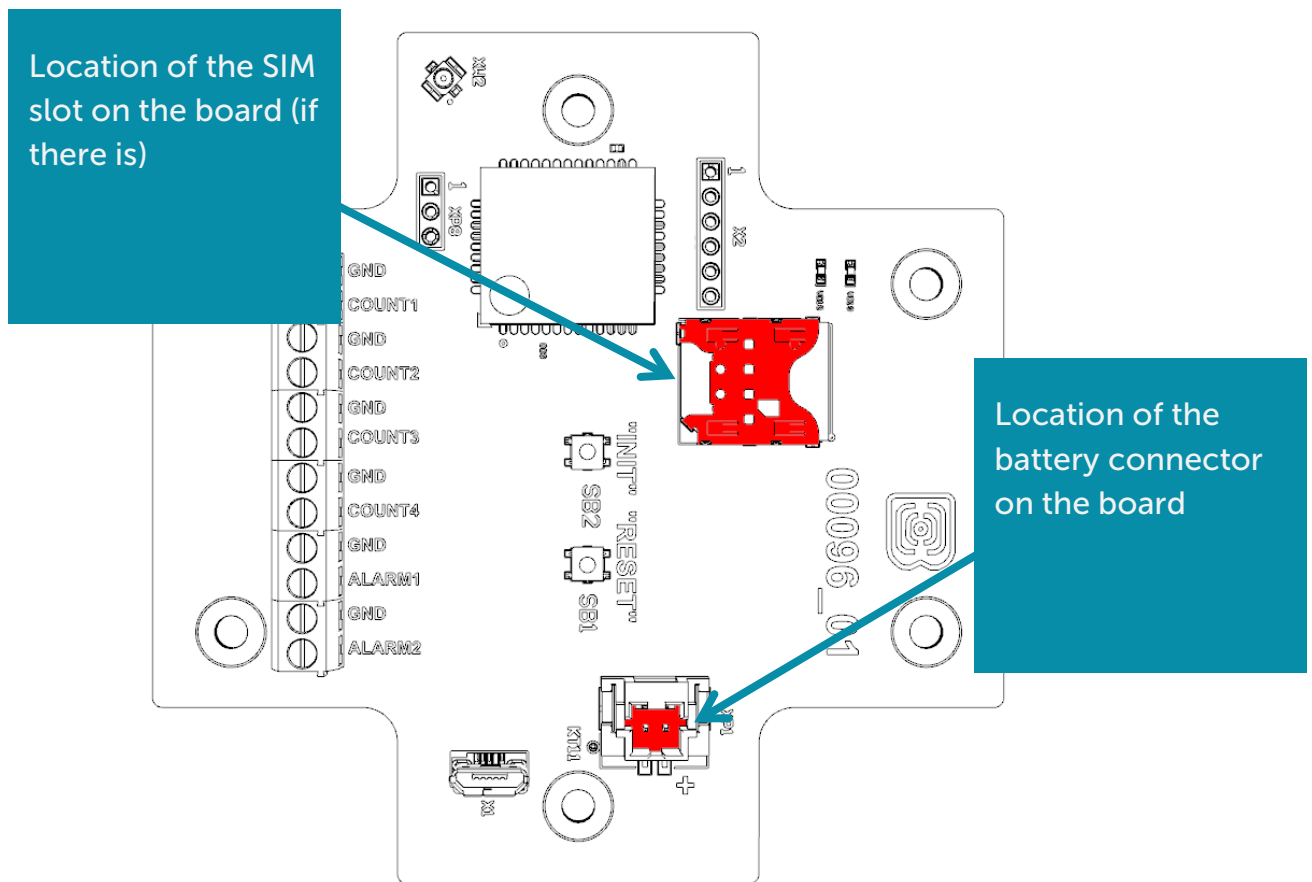

Vega NB-11 modem powered by the built-in battery which comes with. After battery connection the device loading and switch to the ‘Sleep’ mode until the communication session according with the schedule.

If you need to test the data transmitting, then press and hold the INIT button for the 2 seconds.

MOUNTING RECOMMENDATIONS

When you connect the pulse output of the metering device to the counting input of the modem, it is recommended to use braided shielding wires, and to install the metering device with the modem away from sources of radio interference. It is recommended to use a two-wire screened wire. The shield is connected on the side of the pulse counter to its ground.

- 1 wire – the signal from the pulse output is connected to the terminal COUNT
- 2 wire – ground, connects to terminal GND
- Shield – connects to terminal GND

CONNECTING VIA USB

The pulse counter can be adjusted with the "Vega NB-IoT Configurator" application through the USB connection (See part 4).

Before connecting the device to the computer for the first time, you must install the driver for the COM port **stsw-stm32102**, which can be downloaded from iotvega.com. After running the executable file **VCP_V1.4.0_Setup.exe**, the installer window will appear:

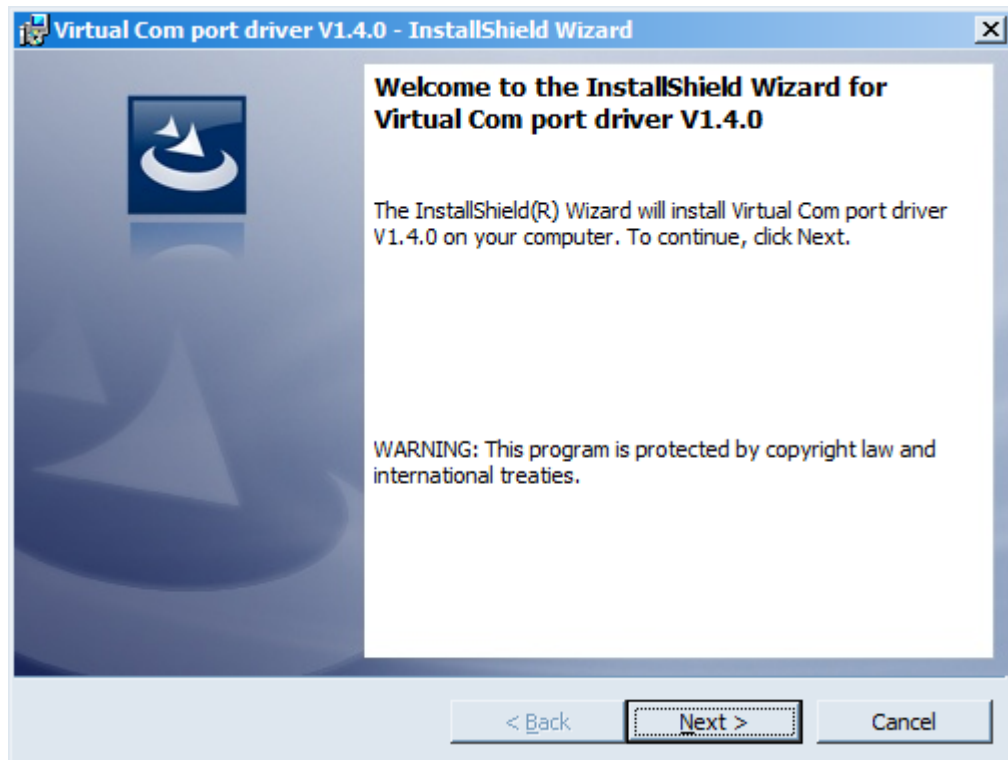

In this window, you need to click **Next**, then **Install**, and then the installation will begin. When the installation is completed successfully, the following screen appears:

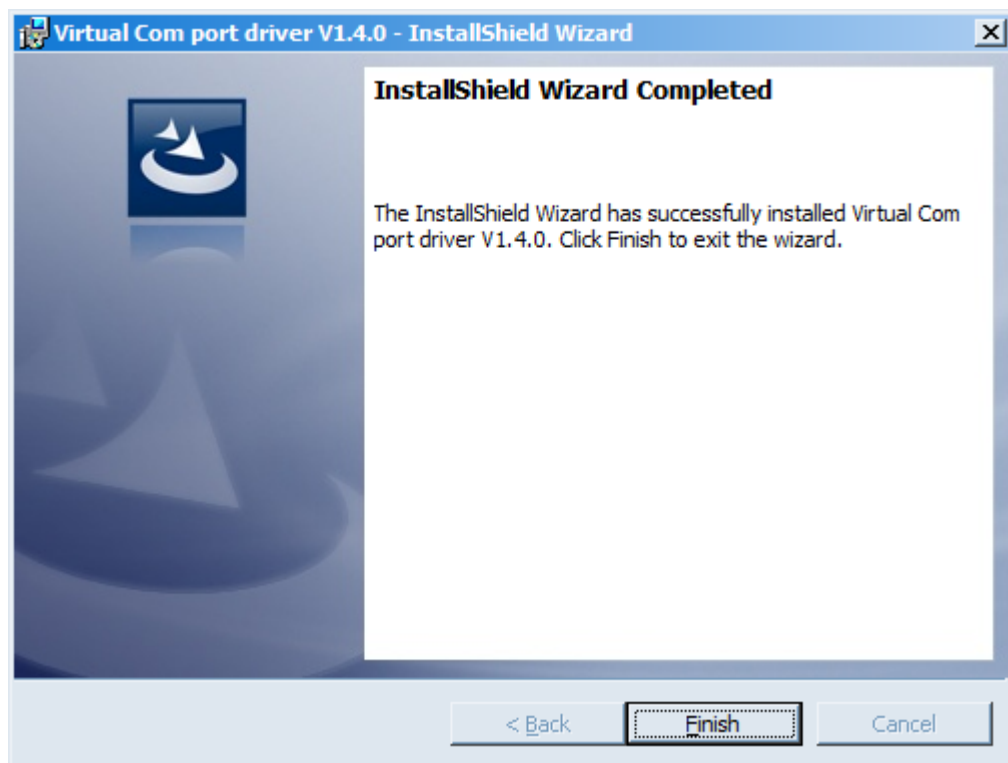

After pressing **Finish** the driver is ready for operation, - it is possible to connect the pulse counter via USB.

4 VEGA NB-IOT CONFIGURATOR

The "Vega NB-IoT Configurator" application (hereinafter referred to as the configurator) is intended for setting up the device via USB.

INTERFACE OF THE APPLICATION

The "Vega NB-IoT Configurator" application does not require the special installation. When the executable file is launched, the window for working with the application appears.

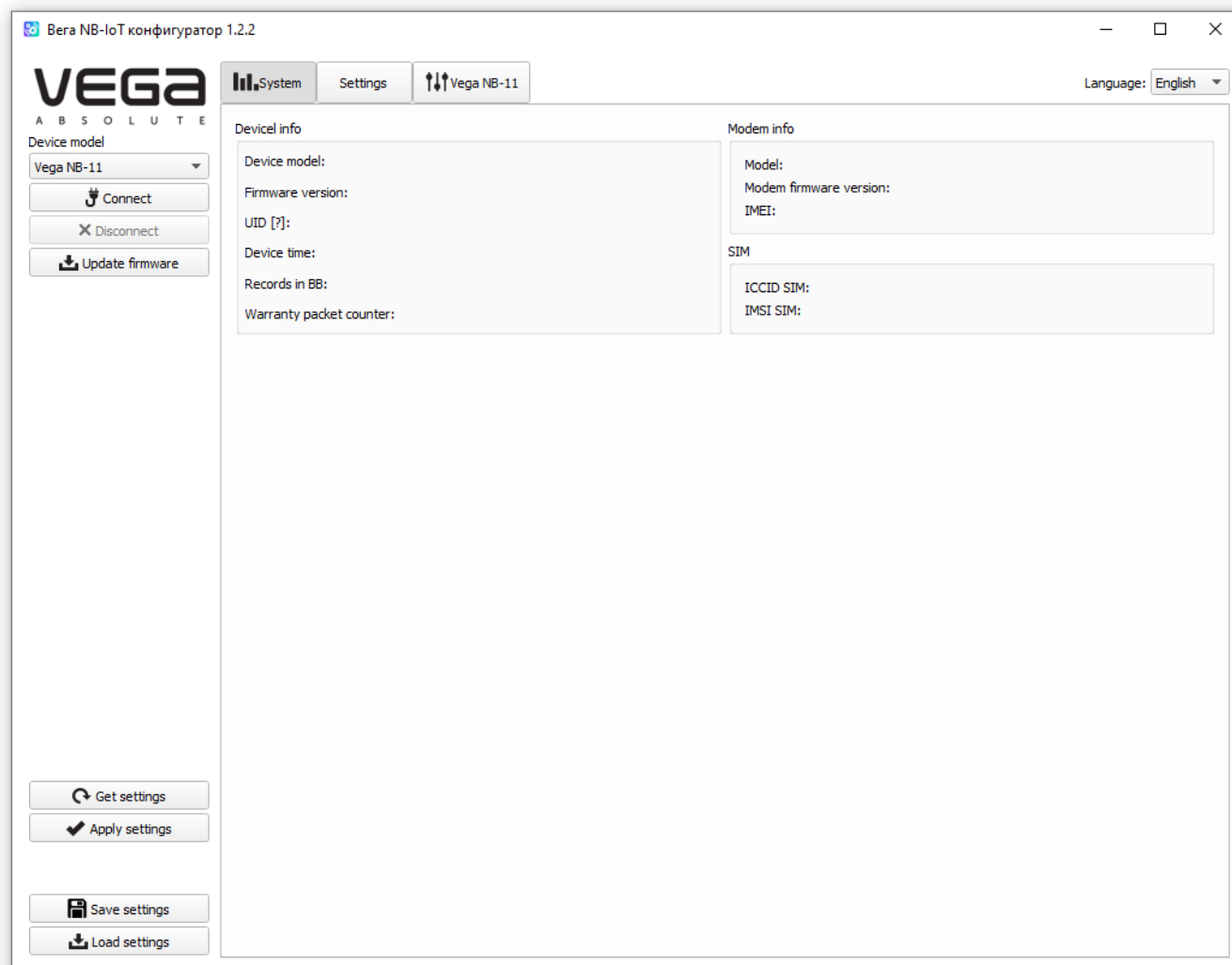

The menu on the left allows you to select the device model, connect to the device or disconnect from it, and update firmware.

The application window contains three tabs – System, Settings and device manage.

CONNECTION TO THE DEVICE

For the connection to the device, perform the following steps:

1. Connect the USB cable to the device.
2. Start the "Vega NB-IoT Configurator" application.
3. Click the "Connect" button in the menu on the left.

The application automatically recognizes the type of device, and the device selection menu becomes inactive.

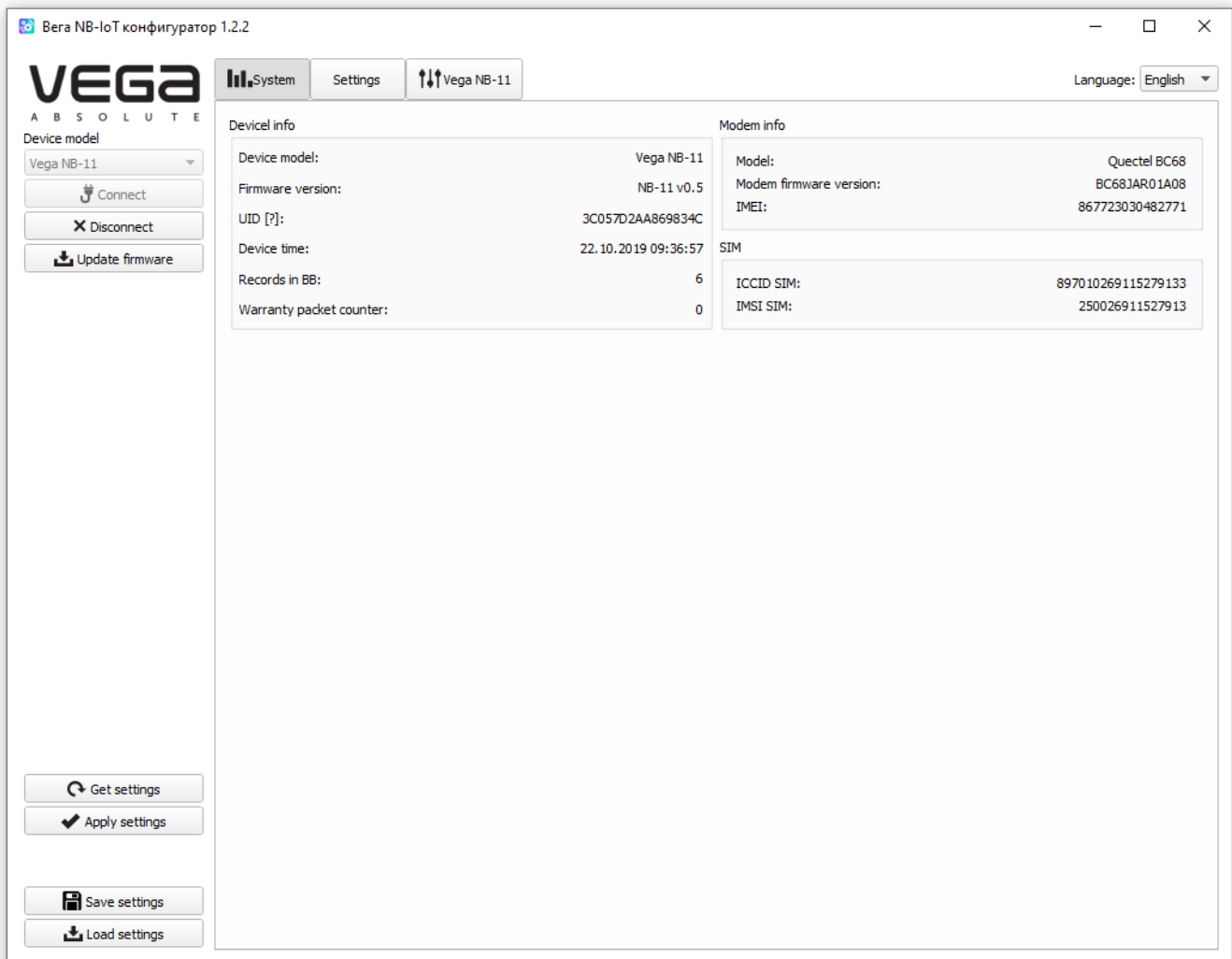

To read the settings from the device, you need to click the "Get settings" button, until this point the application will display the default settings or from the last connected device.

After making the necessary changes to the settings, you should click the "Apply settings" button and only then disconnect from the device with the "Disconnect" button. Also, the application allows to save settings into a file after what you can load it from that file on other similar devices for speed up the debugging process.

"SYSTEM" TAB

The "System" tab displays information about the device, about modem, and SIM.

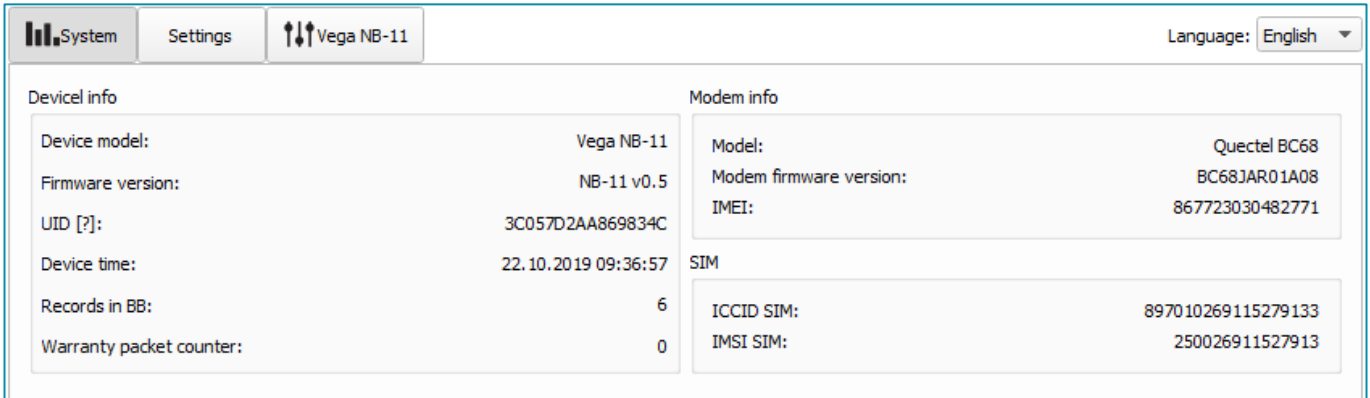

The screenshot shows the "System" tab interface for the Vega NB-11 device. It features a navigation bar with "System", "Settings", and "Vega NB-11" tabs, and a language dropdown set to "English". The main content is divided into three sections: "Device info", "Modem info", and "SIM".

Device info		Modem info	
Device model:	Vega NB-11	Model:	Quectel BC68
Firmware version:	NB-11 v0.5	Modem firmware version:	BC68JAR01A08
UID [?]:	3C057D2AA869834C	IMEI:	867723030482771
Device time:	22.10.2019 09:36:57	SIM	
Records in BB:	6	ICCID SIM:	897010269115279133
Warranty packet counter:	0	IMSI SIM:	250026911527913

Device info - the configurator reads information about the device model, its firmware and automatically corrects the device's time when connected to it. In that block you can find out the number of records in the black box and the number of packets sent by the device.

Modem info – in that block information about LTE-modem is displayed.

SIM – identifiers of the SIM card (SIM chip).

“SETTINGS” TAB

The " Settings" tab allows to configure various parameters of the network connection and device operation.

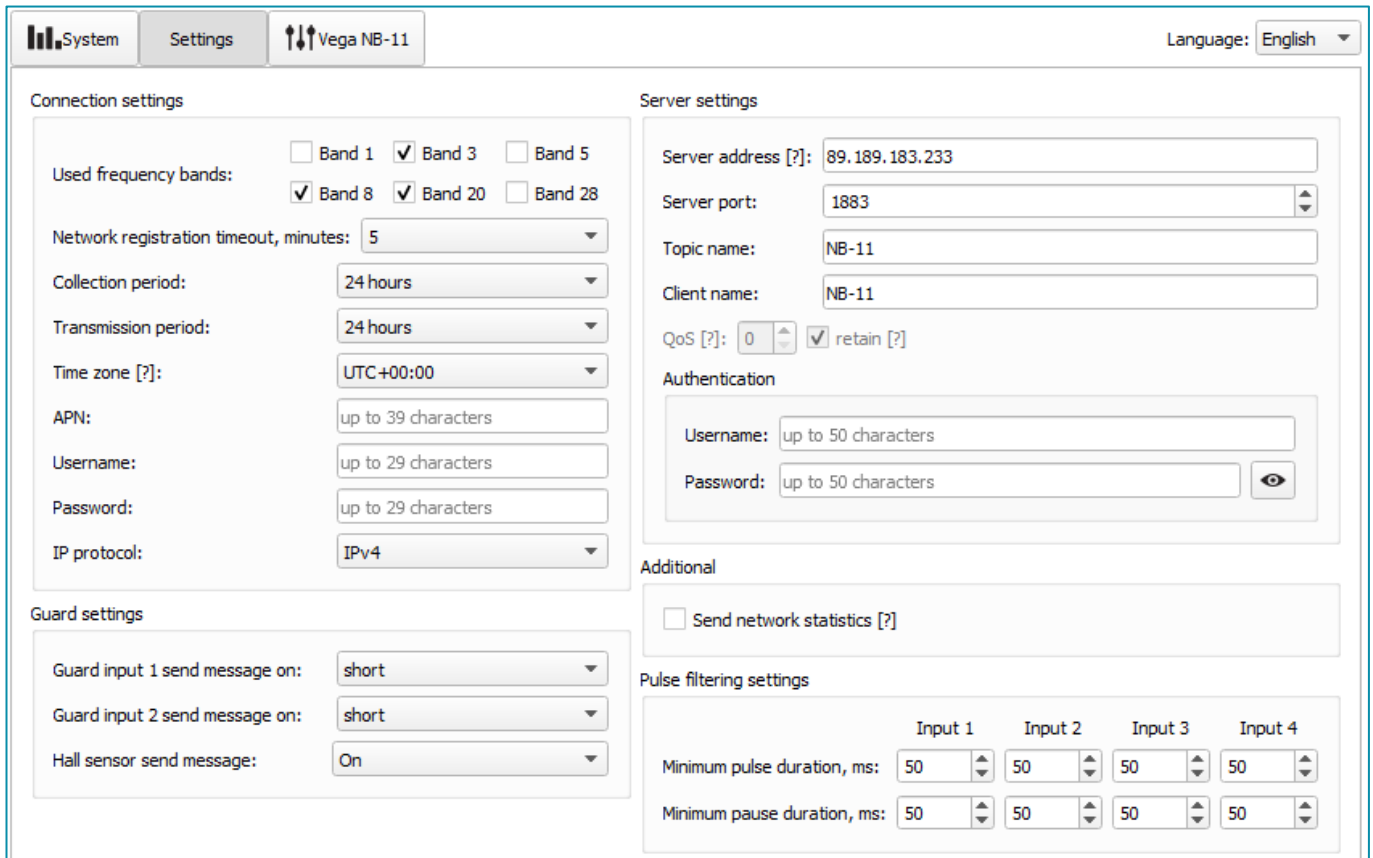

Connection settings – a group of parameters set up the data collection and transmitting.

Used frequency bands for NB-IoT devices connection can be different for different cellular operators. You can ask the operator about used band or select all the bands.

Network registration timeout – it is a period after which the modem will switch to the “Sleep” mode when registration waiting. For battery economy it is better to set minimal period for which the device can registered in the network in the specific covering conditions.

Cellular operator can give you APN or set it by default if the field is empty.

Time zone set up for the data collection period which is equal to the device time (UTC) plus time zone. Transmission period is always use UTC time regardless of the time zone setting.

Readings collected at 00:00 if the collection period is 24 hours; at 00:00 and at 12:00 if the period is 12 hours etc. All readings stored in the device memory until the next communication session.

Transmission period can be equal to 5, 15, 30 minutes, 1, 2, 3, 4, 6, 12 and 24 hours. When beginning of communication session, the device starts sending packets with readings from the earliest packet. The time of data transmitting cannot be specified, it is defined in random way for every device in chosen period of transmission from the moment of connection

to the network. For example, transmission period is 30 minutes, and device was started at 16:40 by the internal device clock. In random way the device calculate data transmitting time and set it at 16:41 in the half-hour period from 16:40 to 17:10. Thus, packets from this device will transmit at 16:41, at 17:11, at 17:41, at 18:11 and so on every 30 minutes by the internal device clock.

By default, packets sent with confirmation and this parameter cannot be changed. The number of retries is 5.

Guard inputs settings – allows to set up mode of security inputs triggering – when security circuit is short, open or in a both cases.

Server settings – settings of connection with MQTT broker.

In **additional** you can receive network statistics. By default, for traffic economy there are no information about connection quality, base station number and other in the packet.

Pulse filtering settings – in this part you can set minimum values of the pulse and pause duration apparently for each of four pulse inputs. Value can be set in milliseconds and can be equal from 2 to 65535 ms.

Minimum pulse duration - the value of the minimum pulse duration in ms, at which the pulse will be recorded by the modem, pulses with a duration less than the specified one will be regarded as bounce and will not be recorded by the modem.

Minimum pause duration - the value of the minimum pause duration in ms, after which the next pulse is let to be fixed.

“VEGA NB-11” TAB

The “Vega NB-11” tab contains detail information about the connected device, its sensors, and inputs.

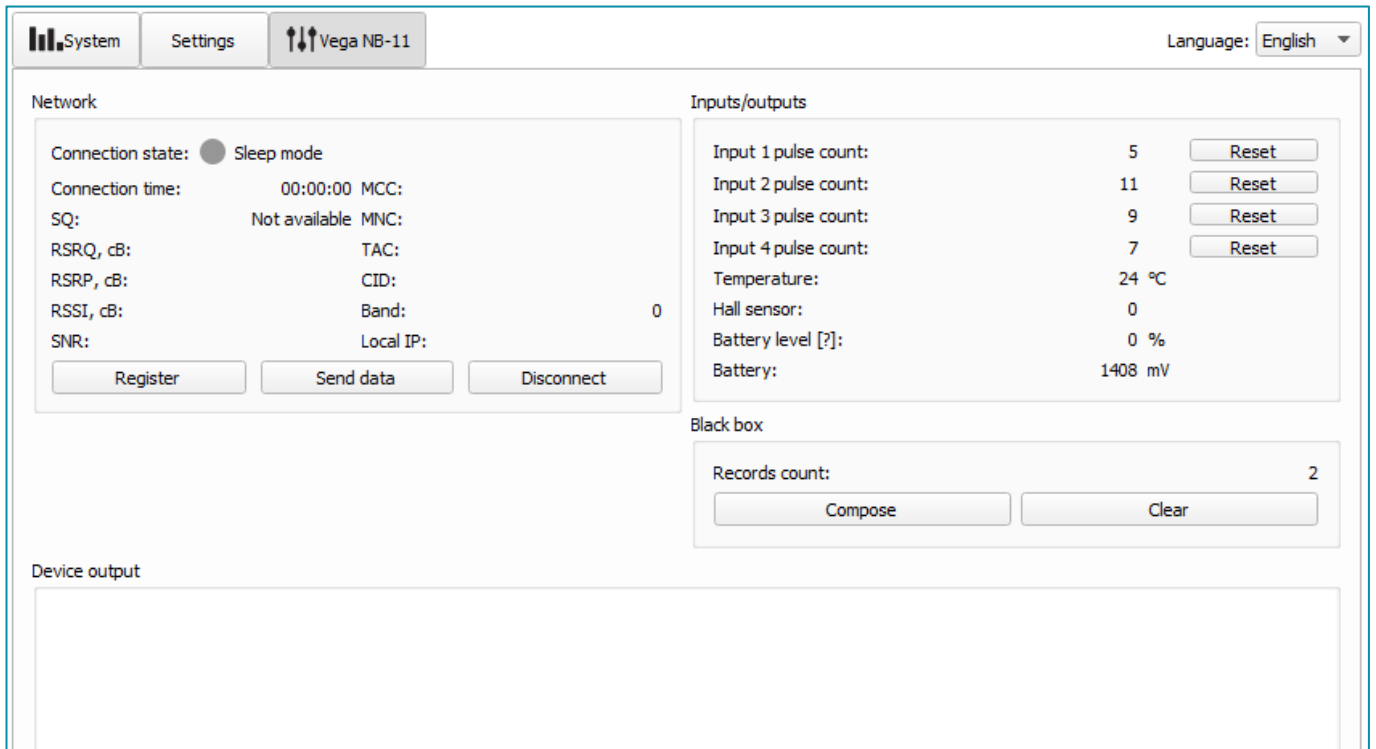

The screenshot shows the Vega NB-11 web interface with the following sections:

- System/Settings/Vega NB-11** (Navigation tabs)
- Language:** English
- Network:**
 - Connection state: Sleep mode
 - Connection time: 00:00:00
 - MCC: Not available
 - SQ: Not available
 - MNC: Not available
 - RSRQ, cB: [value]
 - TAC: [value]
 - RSRP, cB: [value]
 - CID: [value]
 - RSSI, cB: [value]
 - Band: [value]
 - SNR: [value]
 - Local IP: [value]
 - Buttons: Register, Send data, Disconnect
- Inputs/outputs:**
 - Input 1 pulse count: 5 (Reset)
 - Input 2 pulse count: 11 (Reset)
 - Input 3 pulse count: 9 (Reset)
 - Input 4 pulse count: 7 (Reset)
 - Temperature: 24 °C
 - Hall sensor: 0
 - Battery level [?]: 0 %
 - Battery: 1408 mV
- Black box:**
 - Records count: 2
 - Buttons: Compose, Clear
- Device output:** (Empty text area)

Network – displays the current parameters of the connection and allows to control it. Buttons in this block have logic like INIT button on the board.

Inputs/outputs – displays current parameters of the device and allows to reset pulse counters on the inputs.

Black box – there are buttons for black box management and the number of records is displayed. The button “Compose” initiates data collection from all the inputs and this packet is placed in the black box until the next communication session. The button “Clear” deletes all records from the black box.

Device output – displays device’s events in real time.

5 COMMUNICATION PROTOCOL

Data transmits via MQTT protocol. You should to specify in the device settings the address and port of the server where the data will be sent. Those settings specified in application "Vega NB-IoT Configurator". It must be MQTT broker as a server (received side). You should to specify in the device settings the address and port of the broker. Also, you should to specify a topic name where the data published and a client name – the name which the device use for publishing. All those settings specified in "Vega NB-IoT Configurator" in part "MQTT settings". For watching the data sending by the device you should deploy MQTT broker on a PC and subscribe some application on MQTT broker.

Vega NB-11 sends the message on the server as a text of JSON format. See example below.

```
{
  "Message": {
    "dev": "NB-11 v0.5",
    "IMEI": "867723030711633",
    "IMSI": "250990283462252",
    "ICCID": "8970199170730496963",
    "num": 3,
    "UTC": 1571227504
  },
  "CellStatus": {
    "SQ": 19,
    "EARFCN": 1240,
    "PCID": 26,
    "RSRP": -822,
    "RSRQ": -108,
    "RSSI": -744,
    "SNR": 119
  },
  "Telemetry": {
    "reason": "time",
    "UTC": 1571227500,
    "bat": 99,
    "temp": 28,
    "pulse1": 0,
    "pulse2": 0,
    "pulse3": 0,
    "pulse4": 0
    "s_alarm1": 0,
    "s_alarm2": 0,
    "s_magnet": 0,
  }
}
```

Transcription of the message fields:

Message – part with information about current message.

dev – name and version of the device firmware

IMEI – LTE-modem identifier

IMSI, ICCID – SIM-card (SIM-chip) identifiers

num – the number of the message

UTC – the date and the time of message sending in UTC format by Greenwich

CellStatus – part with information about the cellular state

EARFCN – the number of radio frequency channel (absolute)

PCID – physical network address

RSRP – input signal power

RSRQ – input signal quality

RSSI – indicator of the input signal power

SNR – signal to noise ratio

Telemetry – part with collected data (one packet)

reason – reason for packet forming*

UTC – the date and the time of message collecting in UTC format by Greenwich

bat – battery charge

temp – processor temperature

pulse1 – pulse number on the input 1

pulse2 – pulse number on the input 2

pulse3 – pulse number on the input 3

pulse4 – pulse number on the input 4

s_alarm1 – state of ALARM1 input at the time of data slice ("0" - logic zero input, "1" - logic one input)

s_alarm2 – state of ALARM2 input at the time of data slice ("0" - logic zero input, "1" - logic one input)

s_magnet – the presence of an external magnetic field at the time of data slice ("0" - absent, "1" - presence)

*Possible values for **Reason** field (Reason for packet forming):

time – packet formed by the time (data collection period set up in the Configurator for the device)

alarm1 – packet formed by the alarm on the input "ALARM1" (communication session initiated by this event)

alarm2 – packet formed by the alarm on the input "ALARM2" (communication session initiated by this event)

cnfg – packet formed by the command from Configurator

hall sensor – packet formed by the Hall sensor (communication session initiated by this event)

button – packet formed by the button pressing (communication session initiated by this event)

6 STORAGE AND TRANSPORTATION REQUIREMENTS

Vega NB-11 pulse counter shall be stored in the original packaging in heated room at temperatures +5°C to +40°C and relative humidity less than 85%.

The counter shall be transported in covered freight compartments of all types at any distance at temperatures -40°C to +85°C.

7 CONTENT OF THE PACKAGE

The pulse counter is delivered complete with:

Vega NB-11 pulse counter – 1 pc.

Antenna – 1 pc.

Battery 6400 mAh – 1 pc.

Factory certificate – 1 pc.

8 WARRANTY

The warranty period for the device is 3 years from the date of sale.

The manufacturer is obligated to provide repair services or replace the failed device during the entire warranty period.

The consumer is obliged to comply with the conditions and rules of transportation, storage and operation specified in this user manual.

Warranty does not apply to:

- the batteries of devices which sent more than 3600 packets;
- the device with mechanical, electrical and / or other damages and defects caused by violation of the transportation, storage and operation requirements;
- the device with traces of repair performed not by the manufacturer's service center;
- the device with traces of oxidation or other signs of liquids leaking inside the device.

In the event of a warranty claim, contact the service center:

113/1, Kirova Str., Novosibirsk, 630008, Russia.

Tel.: +7 (383) 206-41-35.



vega-absolute.ru

User Manual © Vega-Absolute OOO 2019-2021