



NB-IoT MODEM

# VEGA NB-15

User manual



## Document Information

Title	NB-IoT modem Vega NB-15
Document type	Manual – Translation from Russian
Document number	V02-NB15-01
Revision and date	02 - 28 April 2021

This document applies to the following products:

Product name	Type number
Vega NB	Vega NB-15

## Revision History

Revision	Date	Name	Comments
01	22.01.2020	KEV	The first release
02	28.04.2021	KEV	JSON message content has been changed, new communication periods: 2, 3 and 4 hours

# CONTENTS

INTRODUCTION .....	4
1 DESCRIPTION AND OPERATION .....	5
Device description .....	5
Functional .....	5
Marking .....	5
2 SPECIFICATION .....	6
3 OPERATION.....	7
Contacts .....	7
Buttons .....	9
Indication .....	10
Initial Startup .....	11
Connecting via USB .....	11
4 VEGA NB-IoT CONFIGURATOR .....	13
Interface of the application .....	13
Connection to the device .....	14
"System" tab .....	15
"Settings" tab .....	16
"Vega NB-15" tab .....	18
5 COMMUNICATION PROTOCOL .....	20
Data collection mode .....	20
6 STORAGE AND TRANSPORTATION REQUIREMENTS .....	22
7 CONTENT OF THE PACKAGE .....	23
8 WARRANTY.....	24

## INTRODUCTION

This manual is designated for Vega NB-15 modem (hereinafter – the modem) manufactured by Vega-Absolute OOO and provides information on powering and activation procedure, control commands and functions of the counter.

This manual is targeted at specialists familiar with installation work fundamentals of electronic and electrical equipment.



**The counter shall be installed and adjusted by qualified specialists in order to ensure proper operation of the device**

Vega-Absolute OOO reserves the right to make changes to the manual related to the improvement of equipment and software, as well as to eliminate typos and inaccuracies, without prior notice.

# 1 DESCRIPTION AND OPERATION

## DEVICE DESCRIPTION

---

Vega NB-15 modem is designed for the data collection from the external connected devices and transmitting it to the server by the NB-IoT technology.

In addition, Vega NB-15 can be used as a security device – two additional inputs operate in security mode, there is also a Hall sensor.

The modem can be used for any utilities' meters and industrial equipment with RS-485 interface, with analog or digital outputs or for the periodic collection of temperature values from the 1-Wire sensors.

Vega NB-15 has an external NB-IoT antenna and ingress protection rating IP65.

The modem is powered by one or two batteries with 6400 mA capacity or by an external supply with power 5...55 V.

## FUNCTIONAL

---

Vega NB-15 modem has the following features:

- RS-485 interface through ModBus protocol
- 1-Wire interface for connection of temperature sensors (up to 10)
- Two digital inputs which can also operating in the «security» mode for connecting the external leakage and safety sensors, etc.
- Two analog inputs
- Queue for sending packages when delivery is not possible
- Time referencing of readings by internal clock
- Communication in case of security inputs or Hall sensor actuation
- Temperature measurement
- External voltage measuring

## MARKING

---

Device marked with sticker that contain the next information:

- Device model;
- IMEI;
- Month and year of manufacture;
- QR-code containing IMEI for automatized count.

Sticker located in three places – on device case, in factory certificate and on the packing box.

## 2 SPECIFICATION

### Main

Interfaces	RS-485 (ModBus) / 1-Wire
Analog inputs	2
Digital inputs	2
USB-port	micro-USB, type B
Operating temperatures	-40...+85 °C
Built-in temperature sensor	yes
Quantity of black box records	200

### Cellular communications

Supported Cellular Standards	LTE Cat NB1
Data transfer protocol	MQTT
LTE NB-IoT antenna type	external

### Power

Battery	6400 / 12800 mAh
External power	5...55 V

### Case

Housing dimensions	95 x 95 x 50 mm
Ingress protection rating	IP65

## 3 OPERATION

### CONTACTS

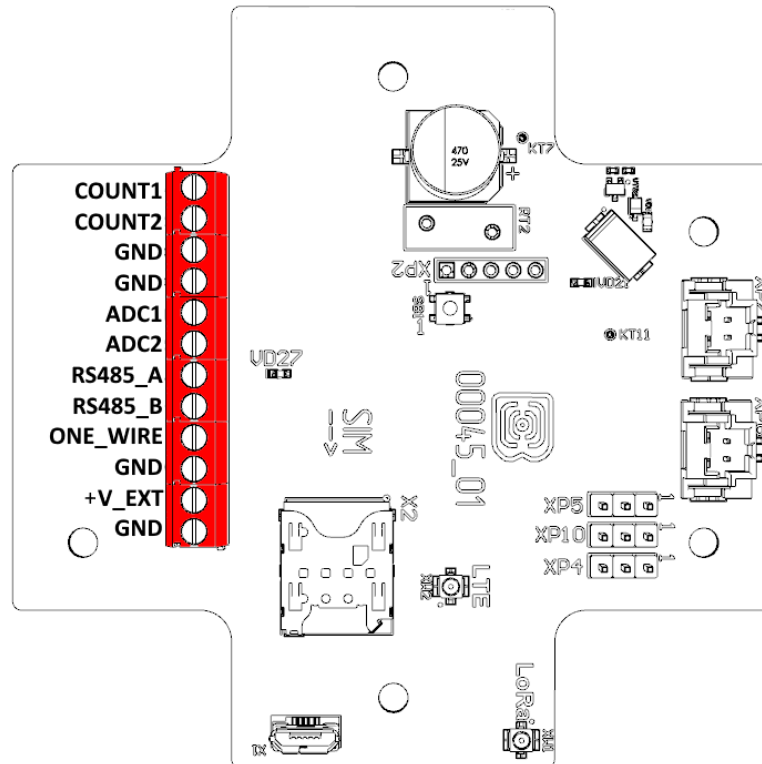

Contacts description is in the table below.

Contact	Name on the board	Description
1	COUNT1	Digital input 1
2	COUNT2	Digital input 2
3	GND	Ground
4	GND	Ground
5	ADC1	Analog input 1 (0...21 B)
6	ADC2	Analog input 2 (0...21 B)
7	RS485_A	RS-485 Interface A
8	RS485_B	RS-485 Interface B
9	ONE_WIRE	1-Wire Interface
10	GND	Ground
11	+V_EXT	External power +
12	GND	External power -

Digital inputs COUNT1 and COUNT2 may operate in pulse or security mode. If the input has not connected there is a logic '1'.

In the pulse mode the modem counts the number of pulses at the input. Fixation is by the impulse slump. In the security mode the modem monitors the input state change and send an alarm message into the network by the one of events: security circuit close, unclose or both of it. You can choose the event for security input triggering via the “Vega NB-IoT Configurator” application.

Analog inputs ADC1 and ADC2 may be used for measuring an external voltage from 0 to 21 V.

RS-485 (modbus) and 1Wire interfaces cannot connecting at the same time. Switching between two interfaces carried out with jumpers on the XP4 and XP5 connectors on the board.

1-Wire interface allows to connect is up to 10 external thermistors (see part 4).

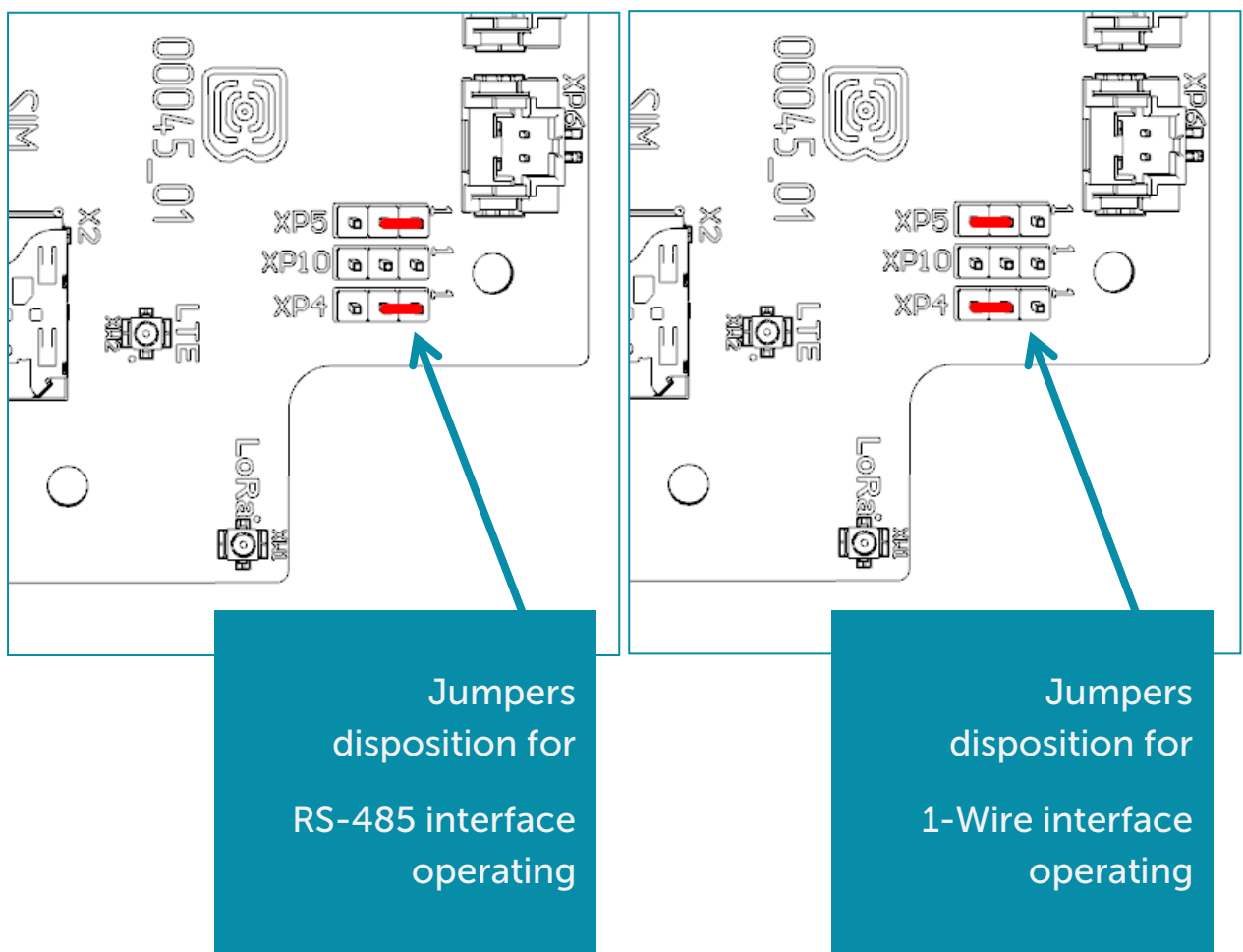



## BUTTONS

There is a button on the board which described in the table below.

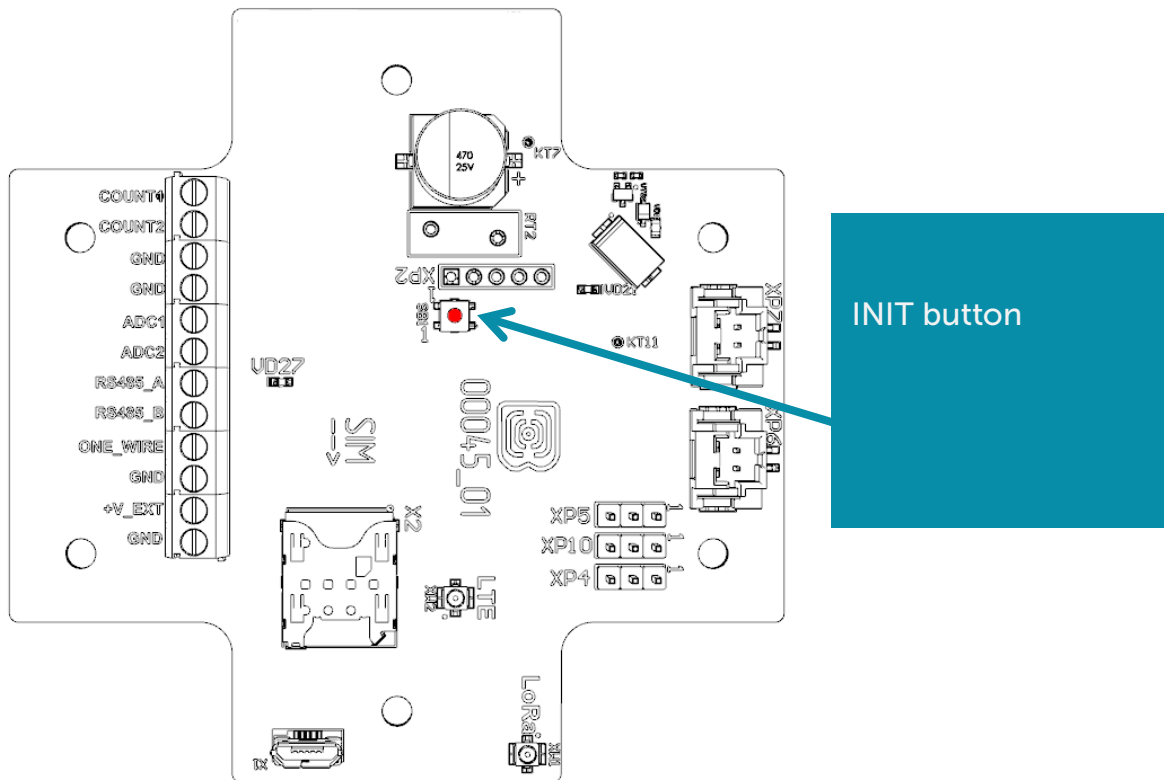





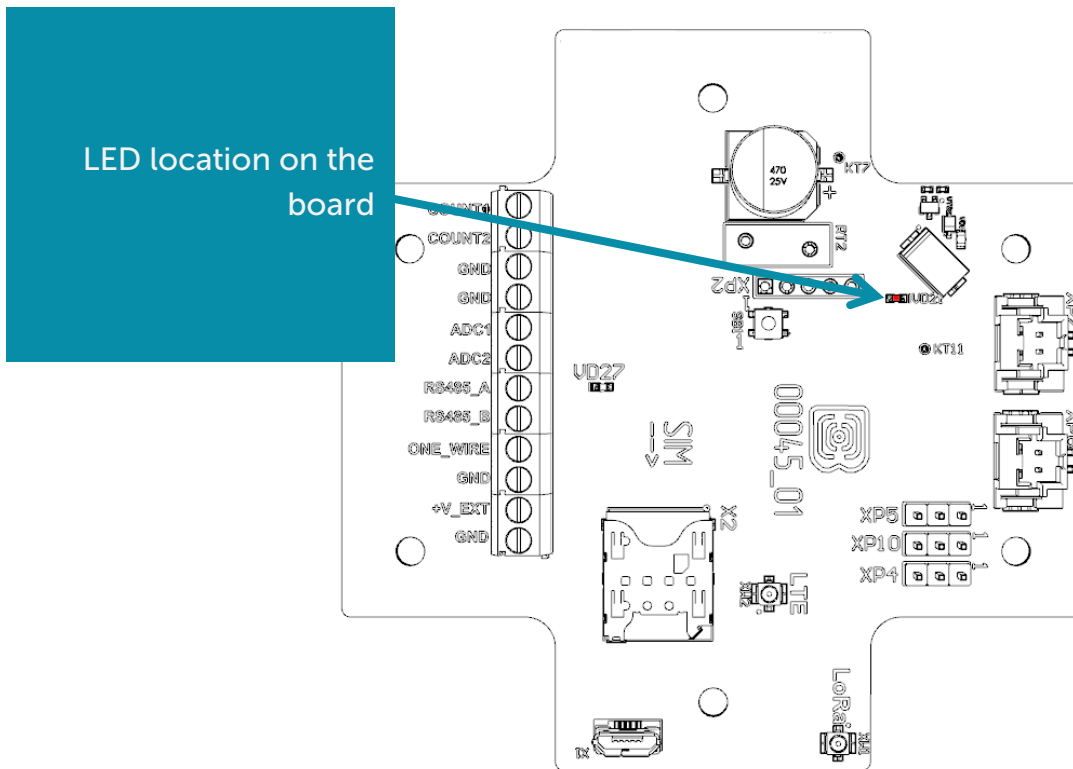

Action	Result
<b>INIT</b>	
Pressing for 1 second	Registration at the network
Pressing for 2 seconds	Data transmitting
Pressing for 3 seconds	LTE-modem switching off
Pressing for 3 seconds	Packet generation
Short pressing	Device reset

When you hold down the button, the red LED starts flashing once a second, which will help you to find out the duration of pressing. Pressing for 1 second corresponds to one flash of the LED, pressing for 2 seconds corresponds to two and so on.

INDICATION

There is a red LED on the board. LED shows the device state.



LED signal	Meaning
	Short flash every three seconds Device searches the network
	Short flash every second Device successfully connected to the network
	Two short flashes every second Device transmits data to the network
	Short flash every five seconds Device in the "Operation" mode
	No light Device in the "Sleep" mode or switched off

## INITIAL STARTUP

Firstly, it is necessary to install SIM into slot on the board and set up the data transmitting with “Vega NB-IoT Configurator” (See part 4).

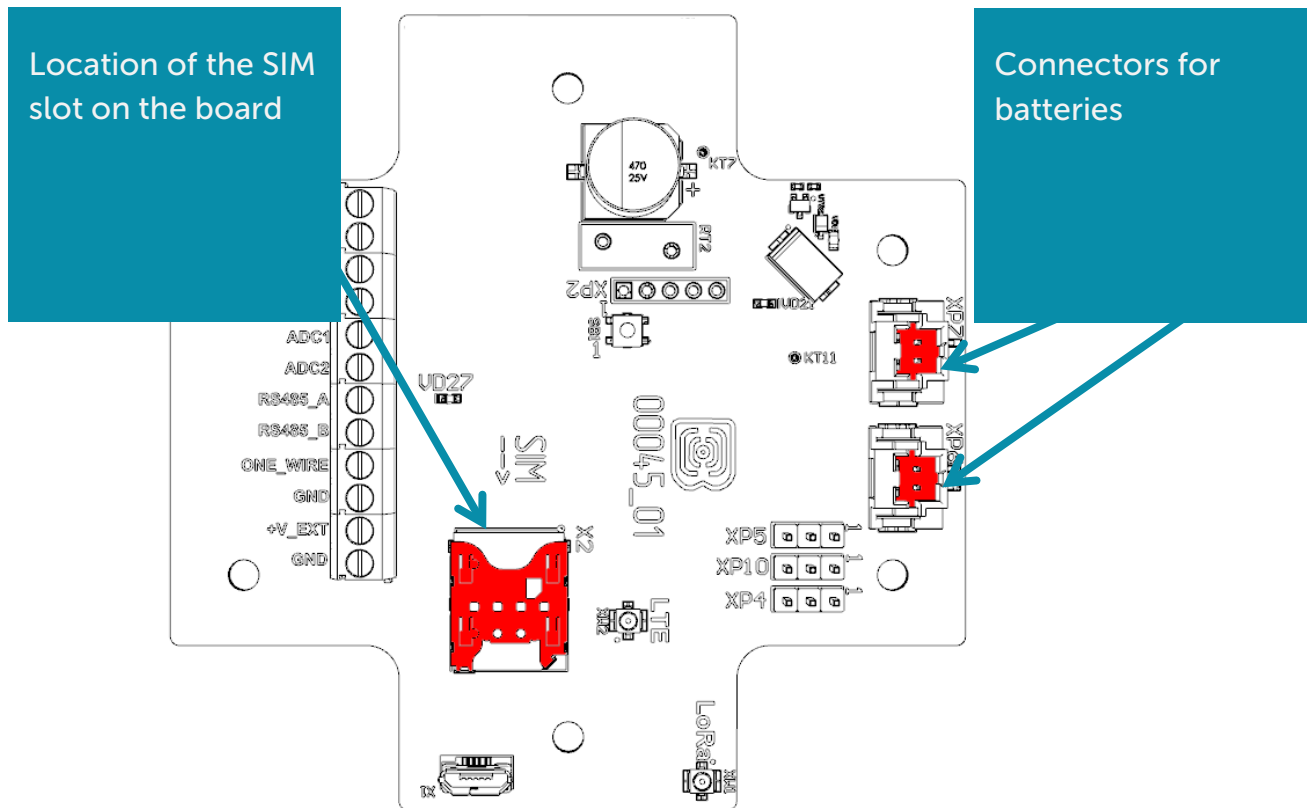

Vega NB-15 modem can be powered from either an external power source or built-in battery. To operate from the built-in battery, you must connect the battery connector to the one of power connectors on the board which XP7 or XP6 marked. In case of operation with two batteries you should use both connectors.

After power supplying the device loading and sleeps until the communication session according with the schedule.

If you need to test the data transmitting, then press and hold the INIT button for the 2 seconds.

## CONNECTING VIA USB

The modem can be adjusted with the "Vega NB-IoT Configurator" application through the USB connection (See part 4).

Before connecting the device to the computer for the first time, you must install the driver for the COM port **stsw-stm32102**, which can be downloaded from [iotvega.com](http://iotvega.com). After running the executable file **VCP\_V1.4.0\_Setup.exe**, the installer window will appear:

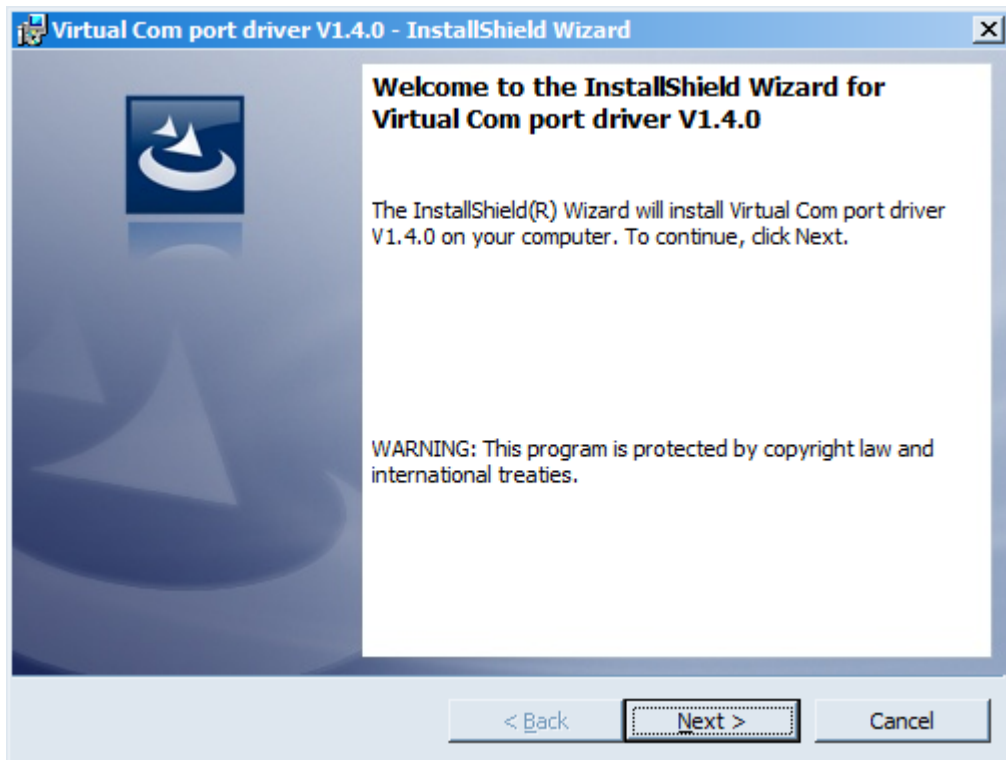

In this window, you need to click **Next**, then **Install**, and then the installation will begin. When the installation is completed successfully, the following screen appears:

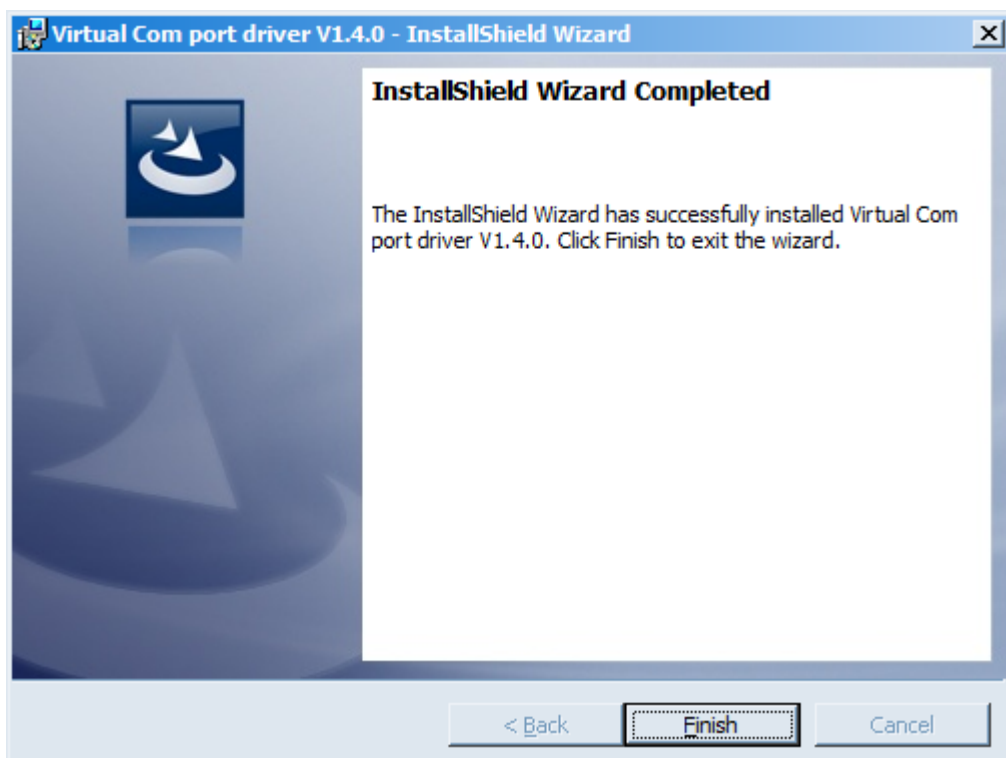

After pressing **Finish** the driver is ready for operation, - it is possible to connect the modem via USB.

## 4 VEGA NB-IOT CONFIGURATOR

The "Vega NB-IoT Configurator" application (hereinafter referred to as the configurator) is intended for setting up the device via USB.

### INTERFACE OF THE APPLICATION

The "Vega NB-IoT Configurator" application does not require the special installation. When the executable file is launched, the window for working with the application appears.

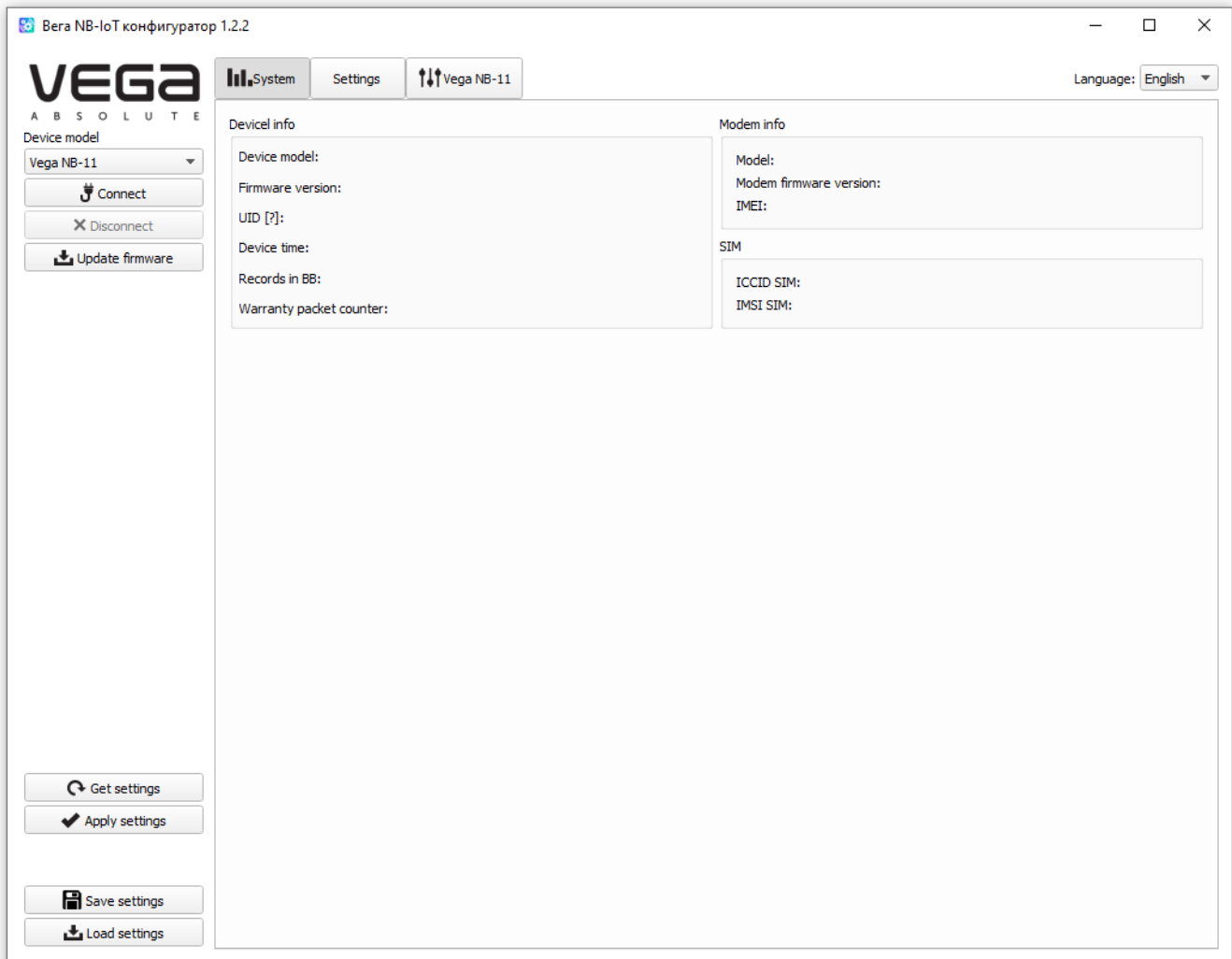

The menu on the left allows you to select the device model, connect to the device or disconnect from it, and update firmware.

The application window contains three tabs – System, Settings and device manage.

## CONNECTION TO THE DEVICE

For the connection to the device, perform the following steps:

1. Connect the USB cable to the device.
2. Start the "Vega NB-IoT Configurator" application.
3. Click the "Connect" button in the menu on the left.

The application automatically recognizes the type of device, and the device selection menu becomes inactive.

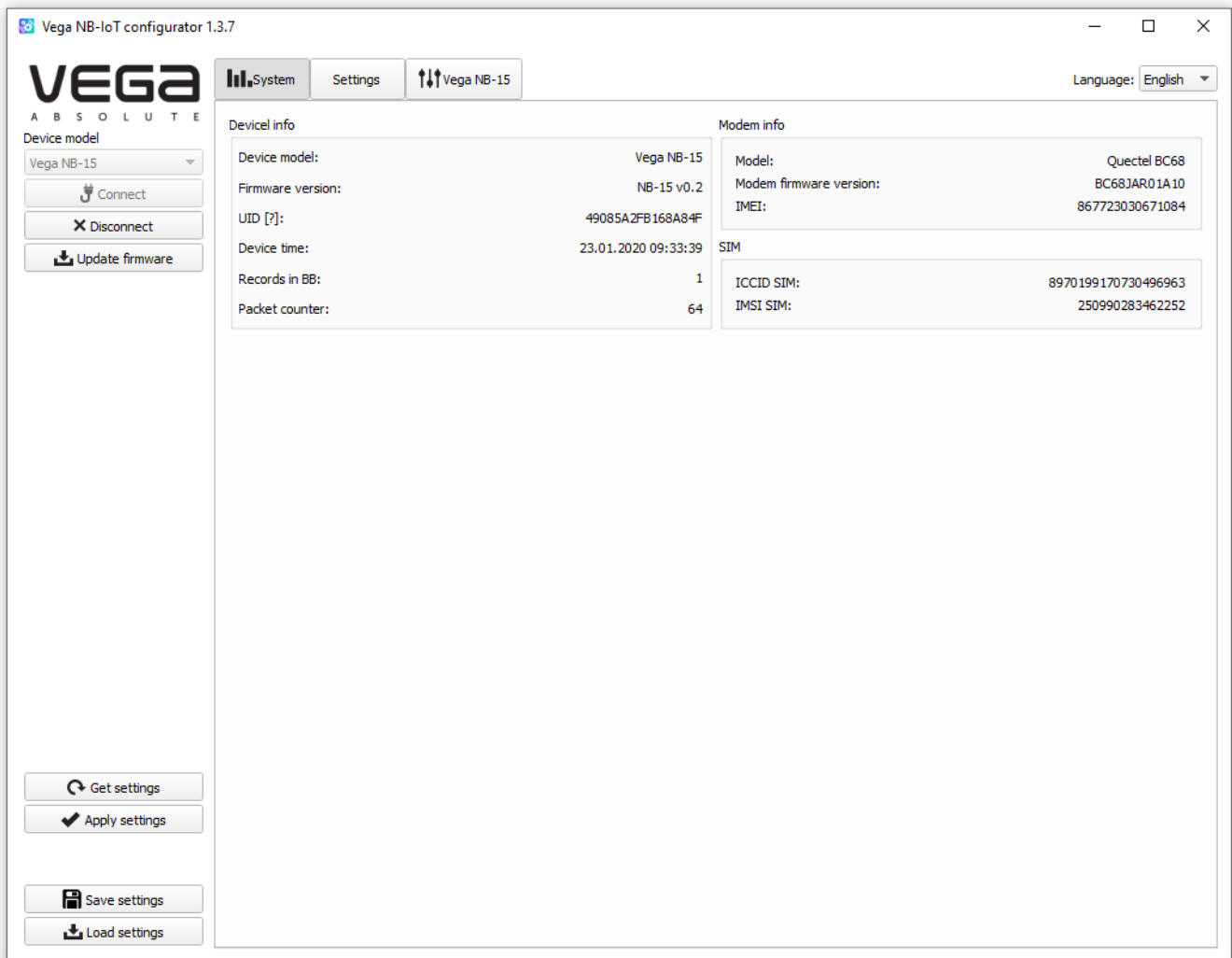

To read the settings from the device, you need to click the "Get settings" button, until this point the application will display the default settings or from the last connected device.

After making the necessary changes to the settings, you should click the "Apply settings" button and only then disconnect from the device with the "Disconnect" button. Also, the application allows to save settings into a file after what you can load it from that file on other similar devices for speed up the debugging process.

## "SYSTEM" TAB

The "System" tab displays information about the device, about modem, and SIM.

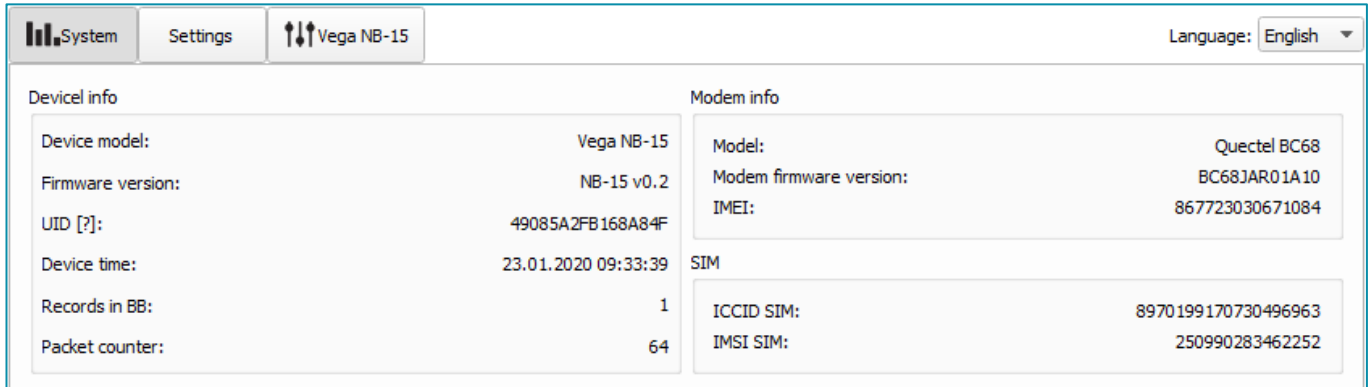

The screenshot shows the "System" tab interface for the Vega NB-15 device. The interface includes a navigation bar with "System", "Settings", and "Vega NB-15" tabs, and a language dropdown set to "English". The main content area is divided into three sections: "Device info", "Modem info", and "SIM".

Device info		Modem info	
Device model:	Vega NB-15	Model:	Quectel BC68
Firmware version:	NB-15 v0.2	Modem firmware version:	BC68JAR01A10
UID [?]:	49085A2FB168A84F	IMEI:	867723030671084
Device time:	23.01.2020 09:33:39	SIM	
Records in BB:	1	ICCID SIM:	8970199170730496963
Packet counter:	64	IMSI SIM:	250990283462252

**Device info** - the configurator reads information about the device model, its firmware and automatically corrects the device's time when connected to it. In that block you can find out the number of records in the black box and the number of packets sent by the device.

**Modem info** – in that block information about LTE-modem is displayed.

**SIM** – identifiers of the SIM card (SIM chip).

## "SETTINGS" TAB

The "Settings" tab allows to configure various parameters of the network connection and device operation.

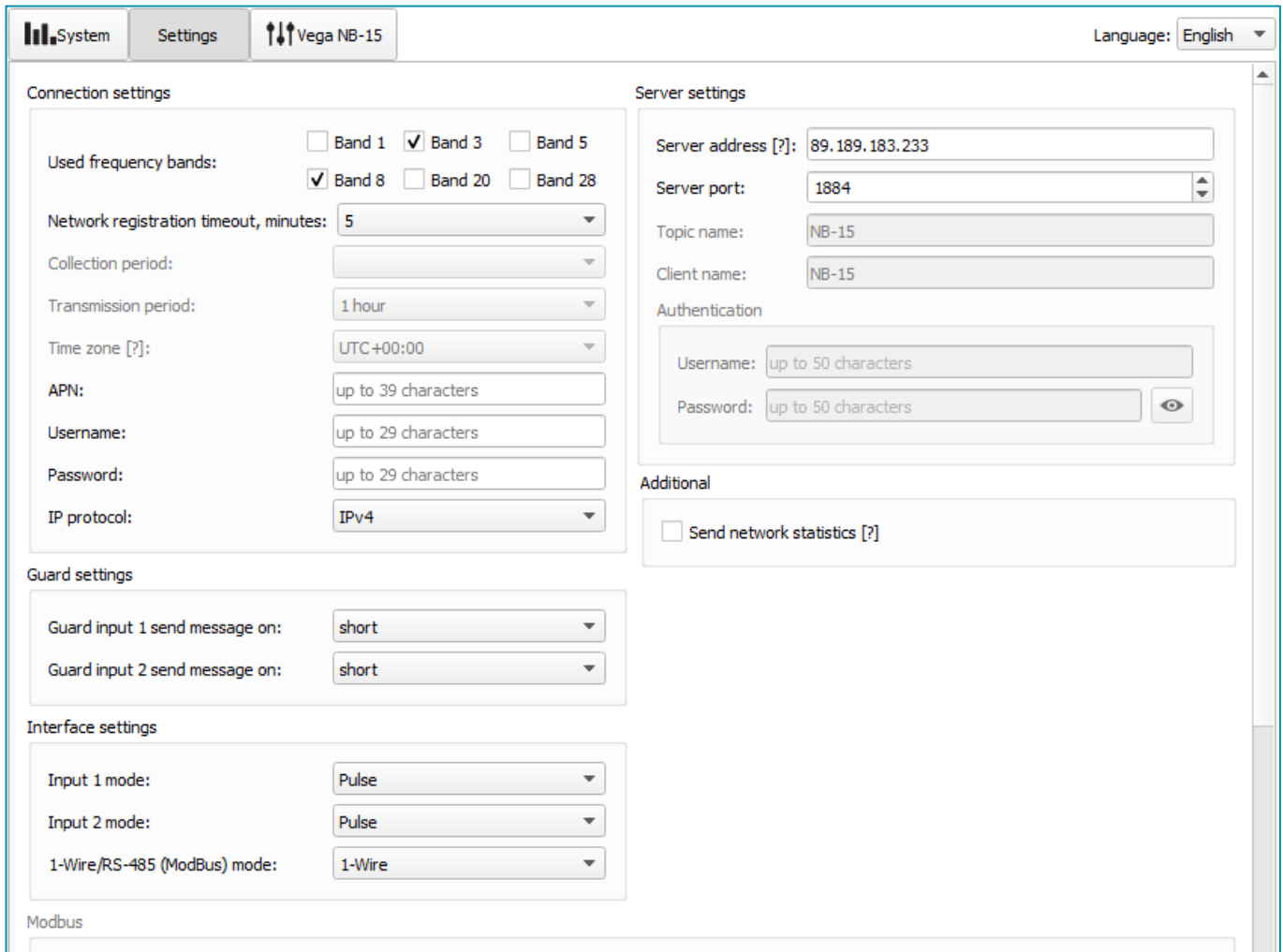

**Connection settings** – a group of parameters set up the data collection and transmitting.

*Used frequency bands* for NB-IoT devices connection can be different for different cellular operators. You can ask the operator about used band or select all the bands.

*Network registration timeout* – the period after which the modem will fall asleep when registration waiting. For battery economy it's better to set minimal period for which the device can be registered in the network in the specific covering conditions.

Cellular operator can give you *APN* or set it by default if the field is empty.

*Time zone* set up for the data collection period which is equal to the device time (UTC) plus time zone. Transmission period is always use UTC time regardless of the time zone setting.

Readings collected at 00:00 if the collection period is 24 hours; at 00:00 and at 12:00 if the period is 12 hours etc. All readings stored in the device memory until the next communication session.



*Transmission period* can be equal to 5, 15, 30 minutes, 1, 6, 12 and 24 hours. When beginning of communication session, the device starts sending packets with readings from the earliest packet. The time of data transmitting cannot be specified, it's defined in random way for every device in chosen period of transmission from the moment of connection to the network. For example, transmission period is 30 minutes, and device was started at 16:40 by the internal device clock. In random way the device calculate data transmitting time and set it at 16:41 in the half-hour period from 16:40 to 17:10. Thus, packets from this device will transmit at 16:41, at 17:11, at 17:41, at 18:11 and so on every 30 minutes by the internal device clock.

**Guard settings** – allows to set up mode of security inputs triggering – when security circuit is short, open or in a both cases.

**Server settings** – settings of connection with MQTT broker.

**Interface settings** – allows setting up the type of every input – it may be pulse or security mode and choose the input mode 1-Wire/ModBus. If you choose the 1-Wire then ModBus settings does not available, if you choose the ModBus then 1-Wire and temperature sensors settings does not available.

In **additional** you can receive network statistics. By default, for traffic economy there are no information about connection quality, base station number and other in the packet.

## "VEGA NB-15" TAB

The "Vega NB-15" tab contains detail information about the connected device, its sensors and inputs.

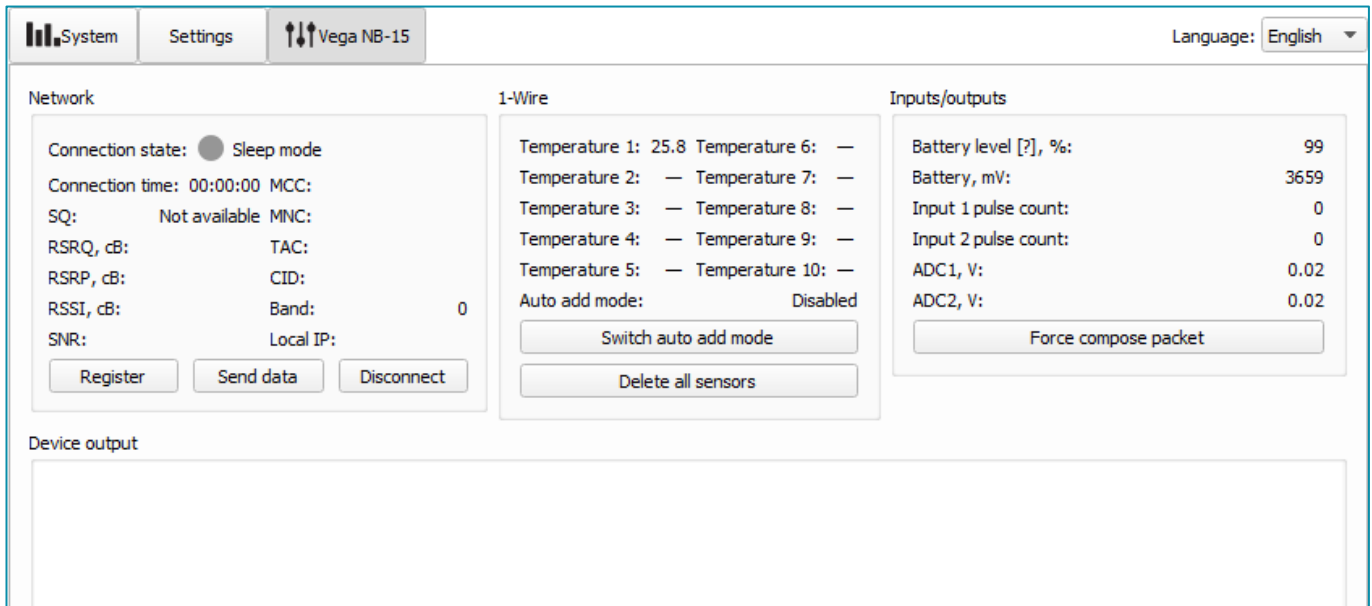

**Network** – displays the current parameters of the connection and allows to control it. Buttons in this block have logic like INIT button on the board.

SQ parameter – Signal Quality – may be from 0 to 31 while connection is on, and 99 value means the connection absent. Table of values is shown below.

Value in program	Signal Quality, dBm
0	-113 and lower
1	-111
2...30	-109...-53
31	-51 and more
99	No connection
100	-116 and lower
101	-115
102...190	-114...-26
191	-25 and more
199	No connection

**1-Wire** – settings of connection external temperature sensors and it's readings. For adding a sensor in system, you need to switch ON the auto add mode. Sensors get numbers in order which them were connected. After switching the auto add mode ON the device starts search the new sensors on the bus. When new sensor is found, the device adds it in memory and the auto add mode OFF automatically. To add the next sensor, you need to switch the auto add mode ON again. All sensors may be removed from the memory with button "Delete all sensors".

**Inputs/outputs** – displays current parameters of the device and allows to form a packet, i. e. to collect data from all the inputs and put the packet to the black box until the next communication session.

**Device output** – displays device's events in real time.

## 5 COMMUNICATION PROTOCOL

### DATA COLLECTION MODE

Data transmits via MQTT protocol. You should to specify in the device settings the address and port of the server where the data will be sent. Those settings specified in application “Vega NB-IoT Configurator”. It must be MQTT broker as a server (received side). You should to specify in the device settings the address and port of the broker. Also, you should to specify a topic name where the data published and a client name – the name which the device use for publishing. All those settings specified in “Vega NB-IoT Configurator” in part “MQTT settings”. For watching the data sending by the device you should to deploy MQTT broker on a PC and subscribe some application on MQTT broker.

Vega NB-15 sends the message on the server as a text of JSON format. See example below.

```
{
  "Message": {
    "dev": "NB-15 v0.8",
    "IMEI": "867723030685126",
    "IMSI": "250990283645008",
    "ICCID": "8970199171166671608",
    "num": 5,
    "UTC": 1618557030
  },
  "CellStatus": {
    "SQ": 27,
    "EARFCN": 1266,
    "PCID": 475,
    "RSRP": -653,
    "RSRQ": -108,
    "RSSI": -593,
    "SNR": 199
  },
  "Telemetry": {
    "reason": "cnfg",
    "UTC": 1618557000,
    "bat": 99,
    "pulse1": 0,
    "pulse2": 0,
    "ADC1": 8,
    "ADC2": 8,
    "temp": 26,
    "s_alarm1": 1,
    "s_alarm2": 1,
    "onewire": [
      26.7
    ]
  }
}
```

```
]
}
}
```

Transcription of the message fields:

**Message** – part with information about current message.

**dev** – name and version of the device firmware

**IMEI** – LTE-modem identifier

**IMSI, ICCID** – SIM-card (SIM-chip) identifiers

**num** – the number of the message

**UTC** – the date and the time of message sending in UTC format by Greenwich

**CellStatus** – part with information about the cellular state (this part displayed only if you check the corresponding function in the configurator)

**SQ** – gateway signal quality

**EARFCN** – the number of radio frequency channel (absolute)

**PCID** – physical network address

**RSRP** – input signal power (in santibells<sup>1</sup>)

**RSRQ** – input signal quality (in santibells<sup>1</sup>)

**RSSI** – indicator of the input signal power (in santibells<sup>1</sup>)

**SNR** – signal to noise ratio

**Telemetry** – part with collected data (one packet)

**reason** – reason for packet forming\*

**UTC** – the date and the time of message collecting in UTC format by Greenwich

**bat** – battery charge

**pulse1** – pulse number on the input 1

**pulse2** – pulse number on the input 2

**ADC1** – voltage value on the analog input 1

**ADC2** – voltage value on the analog input 2

**temp** – processor temperature

**s\_alarm1** – state of ALARM1 input at the time of data slice ("0" - logic zero input, "1" - logic one input)

**s\_alarm2** – state of ALARM2 input at the time of data slice ("0" - logic zero input, "1" - logic one input)

**onewire** – values of temperatures of sensors on 1-Wire bus

---

<sup>1</sup> Decibels multiplied by 10

## 6 STORAGE AND TRANSPORTATION REQUIREMENTS

Vega NB-15 modem shall be stored in the original packaging in heated room at temperatures +5°C to +40°C and relative humidity less than 85%.

The modem shall be transported in covered freight compartments of all types at any distance at temperatures -40°C to +85°C.

## 7 CONTENT OF THE PACKAGE

The modem is delivered complete with:

Vega NB-15 modem – 1 pc.

Antenna – 1 pc.

Factory certificate – 1 pc.

## 8 WARRANTY

The warranty period for the device is 3 years from the date of sale.

The manufacturer is obligated to provide repair services or replace the failed device during the entire warranty period.

The consumer is obliged to comply with the conditions and rules of transportation, storage and operation specified in this user manual.

Warranty does not apply to:

- the device with mechanical, electrical and / or other damages and defects caused by violation of the transportation, storage and operation requirements;
- the device with traces of repair performed not by the manufacturer's service center;
- the device with traces of oxidation or other signs of liquids leaking inside the device.

In the event of a warranty claim, contact the service center:

113/1, Kirova Str., Novosibirsk, 630008, Russia.

Tel.: +7 (383) 206-41-35.





[vega-absolute.ru](http://vega-absolute.ru)

User Manual © Vega-Absolute OOO 2020-2021