



Pulse Counter

# VEGA SI-11

User manual



## Document Information

Title	Pulse Counter Vega SI-11
Document type	Manual – Translation from Russian
Document number	V02-SI11-01
Revision and date	24 - 09 June 2020

This document applies to the following products:

Product name	Type number
Vega SI	Vega SI-11

## Revision History

Revision	Date	Name	Comments
01	24.01.2017	KEV	Document creation date
02	26.01.2017	PKP	Little accuracies was removed
03	27.01.2017	PKP	Exchange protocol description was added
04	30.01.2017	KEV	General correction, formatting etc.
05	01.02.2017	KEV	The preface was added on the cover
06	07.03.2017	PKP	RU868 was added
07	17.03.2017	KEV	New photos, information about stickers, USB was added
08	14.04.2017	KEV	Minor edits
09	10.05.2017	KEV	New photos of the appearance
10	01.06.2017	PKP	Minor edits at the communication protocol
11	17.06.2017	PKP	Fixed error in archive request command
12	11.07.2017	PKP	Fixed error in protocol description
13	16.08.2017	PKP	Adding's in alarm command description
14	08.09.2017	KEV	Part "Vega LoRaWAN Configurator" was added
15	11.10.2017	KEV	Warranty was changed, minor edits
16	10.01.2018	KEV	Minor edits, new illustrations in the "Operation" part
17	04.05.2018	KEV	Edits concerning the field of application with meters with pulse outputs
18	24.07.2018	KEV	Changes in the device logic, removed switches, added frequency plans, changes in the communication protocol, in technical characteristics
19	03.09.2018	PKP KEV	Changes in the communication protocol. Timestamp is added to the alarm packet. Pulse input scheme is added.

20	22.01.2019	KEV	<a href="#">Communication protocol</a> changed, device <a href="#">setting "by the air"</a> added, <a href="#">device AppEui</a> added in specification, " <a href="#">Marking</a> " part added, other inaccuracies fixed
21	24.01.2019	KEV	Inaccuracy in <a href="#">communication protocol</a> fixed – packet type for packets with settings and request of settings
22	19.12.2019	KEV	Fixed inaccuracy about frequency of alarm packets generation, minor changes
23	08.04.2020	KEV	Fixed inaccuracy about data type in " <a href="#">Temperature</a> " field, minor changes
24	09.06.2020	KEV	The battery information is changed in the specification

# CONTENTS

INTRODUCTION .....	5
1 DESCRIPTION AND OPERATION .....	6
Device description .....	6
Communication and data collection algorithm .....	6
Functional .....	7
Marking .....	7
2 SPECIFICATION .....	8
3 OPERATION.....	9
Contacts .....	9
Indication .....	10
Initial Startup .....	11
Connecting via USB .....	12
4 VEGA LORAWAN CONFIGURATOR.....	13
Interface of the application .....	13
Connection to the device .....	14
“Device info” tab .....	15
“LoRaWAN settings” tab .....	16
“Vega SI-11” tab.....	20
5 COMMUNICATION PROTOCOL .....	22
Vega SI-11 pulse counter transmits the following types of packets .....	22
VEGA SI-11 pulse counter receives packets of the following types.....	25
6 STORAGE AND TRANSPORTATION REQUIREMENTS .....	27
7 CONTENT OF THE PACKAGE .....	28
8 WARRANTY.....	29

## INTRODUCTION

This manual is designated for Vega SI-11 pulse counter (hereinafter – the counter) manufactured by Vega-Absolute OOO and provides information on powering and activation procedure, control commands and functions of the counter.

This manual is targeted at specialists familiar with installation work fundamentals of electronic and electrical equipment.



**To provide the stable radio between the gateway and the end device it is recommend avoiding the device installation in the places which are barriers for the radio signal getting through like a reinforced floors and walls, a basement, an underground facilities and wells, a metal case etc. The necessary stage for the network deploying including a big quantity of end devices is a radio planning work with nature experiments**

Vega-Absolute OOO reserves the right to make changes to the manual related to the improvement of equipment and software, as well as to eliminate typos and inaccuracies, without prior notice.

## 1 DESCRIPTION AND OPERATION

### DEVICE DESCRIPTION

Vega SI-11 pulse counter is designed for counting of pulses incoming to 4 independent inputs, further accumulating and transmitting of this information via the LoRaWAN protocol to the gateway through wireless communication within 860-1000 MHz frequency plan.

In addition, Vega SI-11 can be used as a security device - anyone of four inputs can be configured as security input.

The pulse counter can be used for any utilities' meters and industrial equipment with pulse output of herkon type or open-drain type.



**Equipment with NAMUR pulse output is not supported**

De-bouncing logics with 5 msec time constant is integrated in the pulse counter. The pulse counting is carried out for frequencies up to 200 Hz.

The counter is powered by a 3400 mAh built-in battery or 3600 mAh replaceable SAFT LS 17500 battery.



**The device is powered by a non-rechargeable lithium-thionyl chloride (LiSOCl<sub>2</sub>) battery  
Attempts to charge the battery may result in fire**

### COMUNICATION AND DATA COLLECTION ALGORITHM

The readings collecting from the meter with a configurable period from 5 minutes to 24 hours. The readings stored in the device memory and transmitting during the next communication session with the LoRaWAN network.

The adjustable data transfer period can be from 5 minutes to 24 hours. Data transferring in random point in time during set period. At the next communication session, the device starts sending accumulated packets with readings, from the earliest to the latest.

With the "Confirmed uplinks" option turned on, the device will send the next packet only after receiving a confirmation of the delivery of the previous one. If such confirmation have not received after the fulfilled in the settings uplink number of transmission, device completes the communication session until the next one according to the schedule. In this case, the device continues to collect data according to the data collection period and store it in memory. Non-transmitted packets remain in the device memory until the next communication session.

With the "Confirmed uplinks" option turned off, the device just sends all accumulated packets to the network in order from the earliest to the latest. There are no checks of package delivery in this mode. There are no non-transmitted messages in the device memory.

The internal clock is set automatically when device connected to the "Vega LoRaWAN Configurator" via USB, also adjustable via LoRaWAN.

## FUNCTIONAL

Vega SI-11 pulse counter is A class device (LoRaWAN classification) and has the following features:

- ADR support (Adaptive Data Rate)
- Sending of confirmed packets (configurable)
- Two operating modes: "Active" and "Storage"
- Inputs can be switched to «security» mode for connection to external leakage and safety sensors, etc.
- Time referencing of readings by internal clock
- Communication in case of security inputs actuation
- Temperature measurement
- Charge measuring of the built-in battery (%)

## MARKING

Device marked with sticker that contain the next information:

- Device model;
- DevEUI;
- Month and year of manufacture;
- QR-code containing DevEUI for automatized count.

Sticker located in three places – on device case, in factory certificate and on the packing box.

Besides, there is an additional sticker located on the packing box and contains:

- Information about firmware version;
- QR-code containing DevEUI and keys for device registration in network via OTAA method.

## 2 SPECIFICATION

### Main

Double-contact digital inputs	up to 4
Maximum input frequency	200 Hz
Security inputs	up to 4
USB-port	mini-USB, type B
Operating temperatures	-40...+85 °C
Built-in temperature sensor	yes

### LoRaWAN

AppEui by default	7665676173693131
LoRaWAN class	A
Quantity of LoRaWAN channels	16
Frequency plan	RU868, EU868, IN865, AS923, AU915, KR920, US915, KZ865, custom (EU868 based)
Activation type	ABP or OTAA
Communication period	5, 15, 30 minutes, 1, 6, 12 or 24 hours
Data collection period	5, 15, 30 minutes, 1, 6, 12 or 24 hours
Memory amount for storing packets	200 packets
Type of the LoRaWAN antenna	internal
Sensitivity	-138 dBm
Radio coverage in restrained urban conditions	up to 5 km
Radio coverage within line of sight	up to 15 km
Transmitter power by default	25 mW (configurable)
Maximum transmitter power	100 mW

### Power

Battery	3400 mAh built-in or 3600 mAh replaceable SAFT LS 17500 battery
Warranty number of packets sent by the device, not less	80 000

### Case

Housing dimensions	95 x 50 x 45 mm
Ingress protection rating	IP65
Mounting	Clamp fastening to the support, DIN-rail, wall-mounting



## 3 OPERATION

### CONTACTS

When connecting a radio modem to external devices, consider the internal circuitry of its pulse inputs shown below.

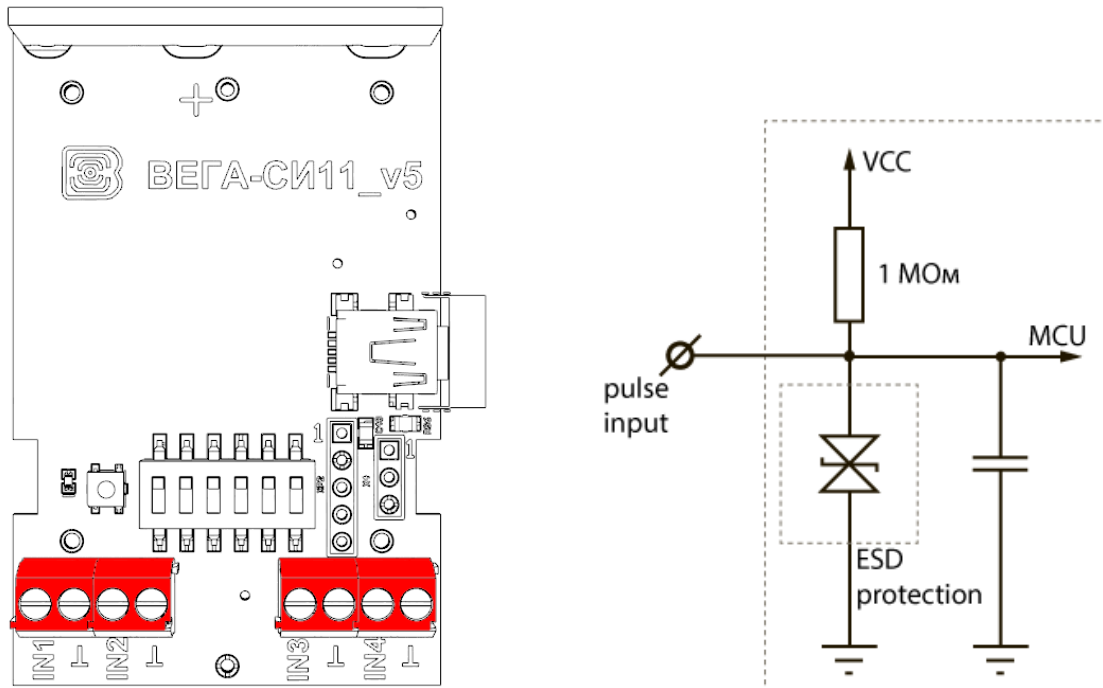

The pulse counter has 4 pairs of contacts that allows to connect circuits with the following types of NO contacts:

- reed switch;
- mechanical pushbutton;
- open-collector output.



**Equipment with NAMUR pulse output is not supported**



Polarity effects only "open collector" circuits.

Pulse inputs can be configured for work in the "Security" mode via the "Vega LoRaWAN Configurator" application. In this mode, the device does not count pulses at the "Security" input, but only monitors its status. Should the "Security" input trigger, the device is activated and sends an alarm message to the network.

**INDICATION**

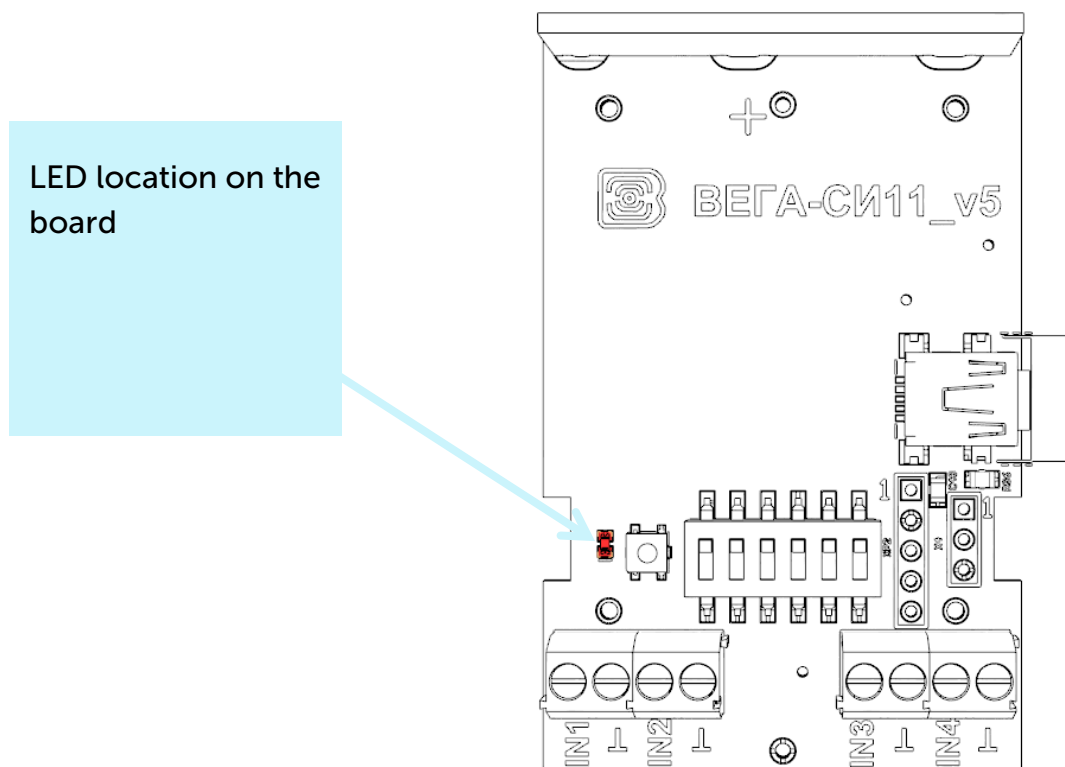
There is one red LED on the board. The indication is only used when the device is activated in the LoRaWAN network and when the operating modes are changed.



LED signal		Meaning
	Series of short flashings	Linking to the network
	One long flashing	The device connected to the network and is in active mode
	Three long flashings	Linking to the network is unsuccessful or the device switched to the «Storage» mode



In case of connection attempt fail, the device will continue to accumulate data and will attempt to connect to the network every 6 hours

## INITIAL STARTUP

Vega SI-11 pulse counter is constantly on, but can operate in a special "Storage" mode, designed for storage and transportation. The device does not regularly transmit data to the network in this mode. Before use switch the counter from the «Storage» mode.

Vega SI-11 supports two activation methods in the LoRaWAN network - ABP and OTAA. Select one of the methods via the "Vega LoRaWAN Configurator" application.

**1. ABP.** After pressing the start button, the device immediately starts working in the "Active" mode.

**2. OTAA.** After pressing the start button, the device makes three attempts to connect to the network within the set frequency plan. After the activation in the LoRaWAN network is confirmed, the device sends a signal (LED flashing for 3 seconds) and switches to the "Active" mode. If all attempts fail, the counter will continue to accumulate data and will attempt to connect to the network every 6 hours.

Hold the start button pressed (min. 5 seconds) to switch the device from the "Active" mode back to the "Storage" mode.



When switching to the "Storage" mode, all readings from the pulse inputs accumulated in the device memory are reset

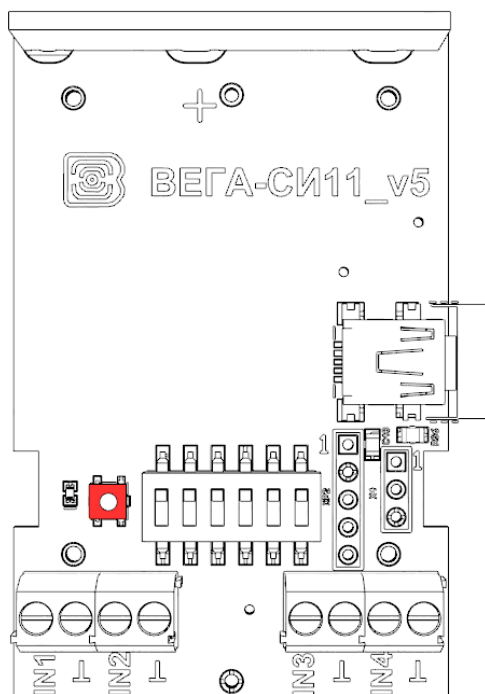

## CONNECTING VIA USB

The pulse counter can be adjusted with the "Vega LoRaWAN Configurator" application (See part 4).

Before connecting the device to the computer for the first time, you must install the driver for the COM port **stsw-stm32102**, which can be downloaded from [iotvega.com](http://iotvega.com). After running the executable file **VCP\_V1.4.0\_Setup.exe**, the installer window will appear:



In this window, you need to click **Next**, then **Install**, and then the installation will begin. When the installation is completed successfully, the following screen appears:

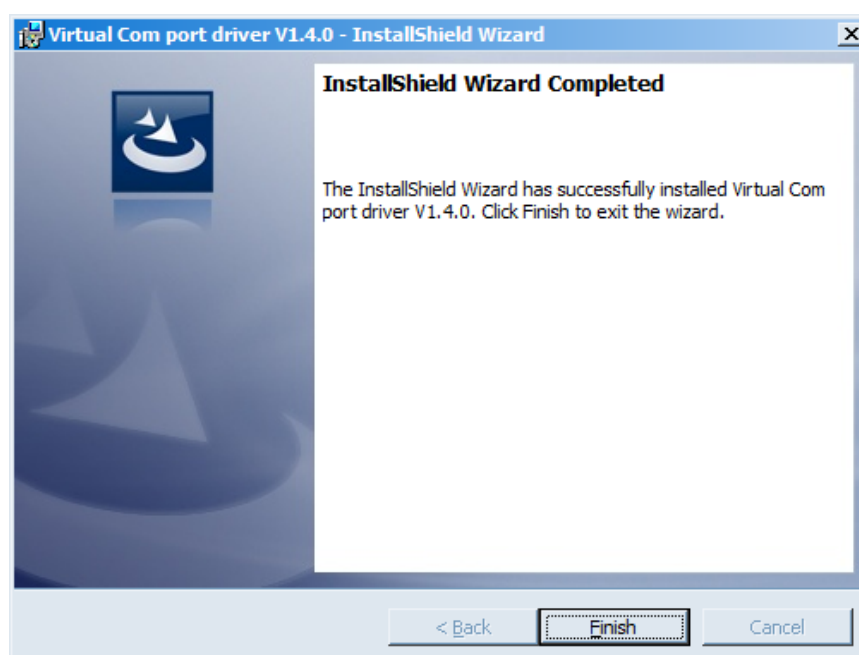

After pressing **Finish** the driver is ready for operation, - it is possible to connect the pulse counter via USB.

## 4 VEGA LORAWAN CONFIGURATOR

The "Vega LoRaWAN Configurator" application (hereinafter referred to as the configurator) is intended for setting up the device via USB.

The configurator has two modes of operation - "Simple" and "Expert". In the "Simple" mode, only basic settings are available. In the "Expert" mode, the basic settings, advanced settings and the ability to check the coverage area of the signal from the gateways are available. Next, the work of the application is considered in the "Expert" mode.

### INTERFACE OF THE APPLICATION

The "Vega LoRaWAN Configurator" application does not require the special installation. When the executable file is launched, the window for working with the application appears.

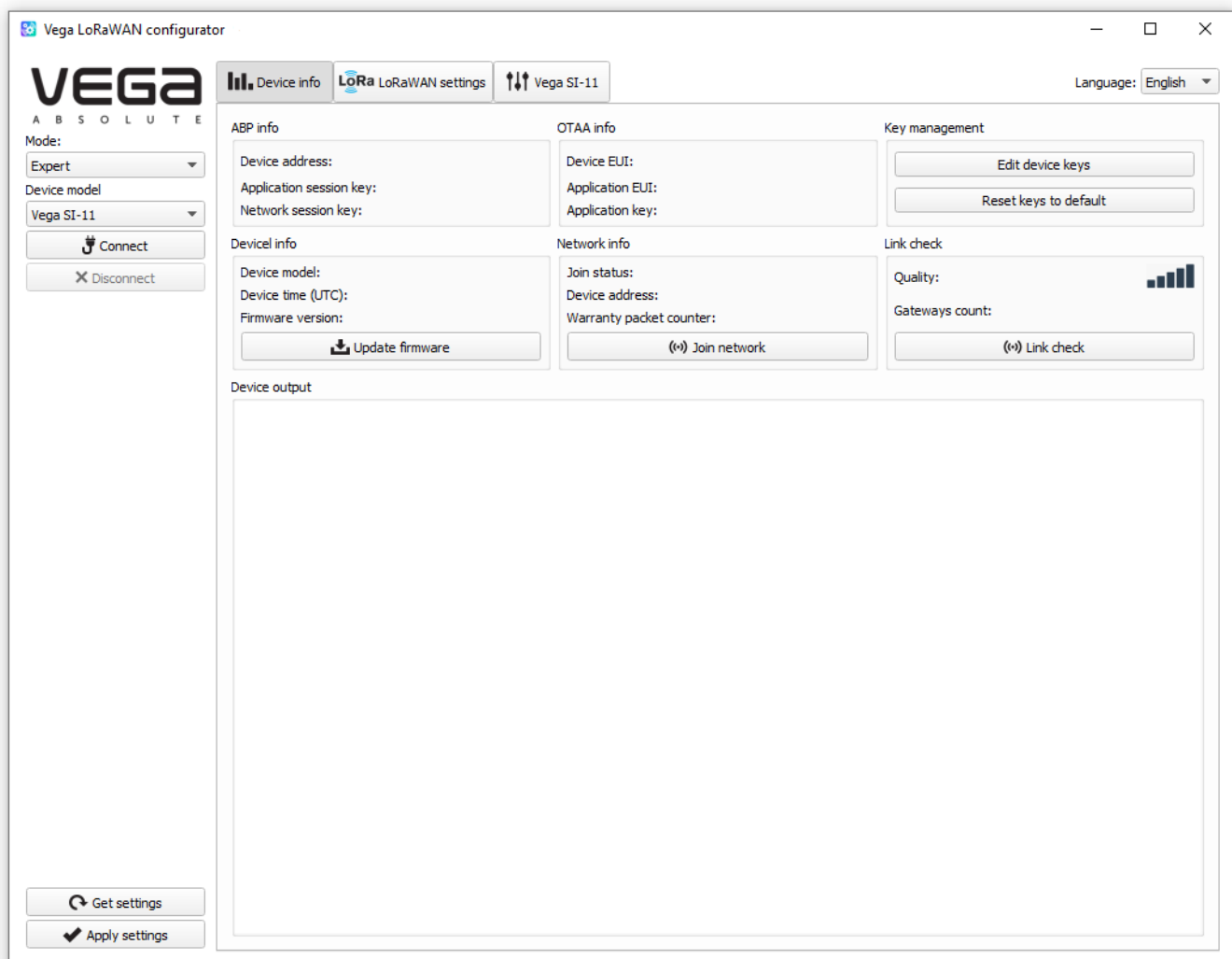

The menu on the left allows you to switch between the "Simple" and "Expert" modes, select the device model, connect to the device or disconnect from it, get and apply settings.

The application window contains three tabs – Device info, LoRaWAN settings and device settings.

The language selection menu is in the upper right corner.

## CONNECTION TO THE DEVICE

For the connection to the device, perform the following steps:

1. Connect the USB cable to the device.
2. Start the "Vega LoRaWAN Configurator" application.
3. Click the "Connect" button in the menu on the left.

The application automatically recognizes the type of device, and the device selection menu becomes inactive.

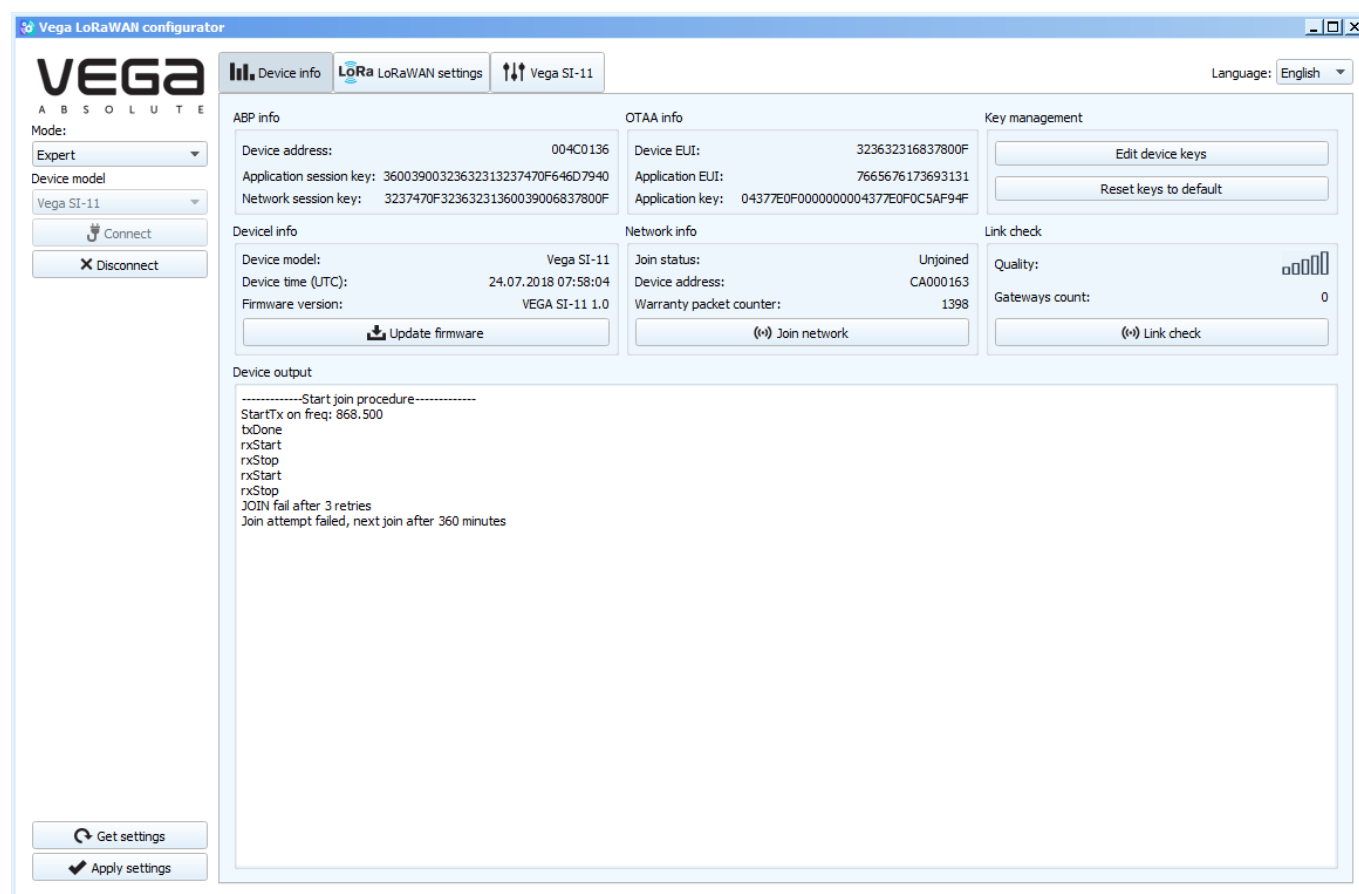

To read the settings from the device, you need to click the "Get settings" button, until this point the application will display the default settings or from the last connected device.

After making the necessary changes to the settings, you should click the "Apply settings" button and only then disconnect from the device with the "Disconnect" button.

## "DEVICE INFO" TAB

The "Device info" tab displays information about the device, its current status, and also the data needed to register the device in the LoRaWAN network.

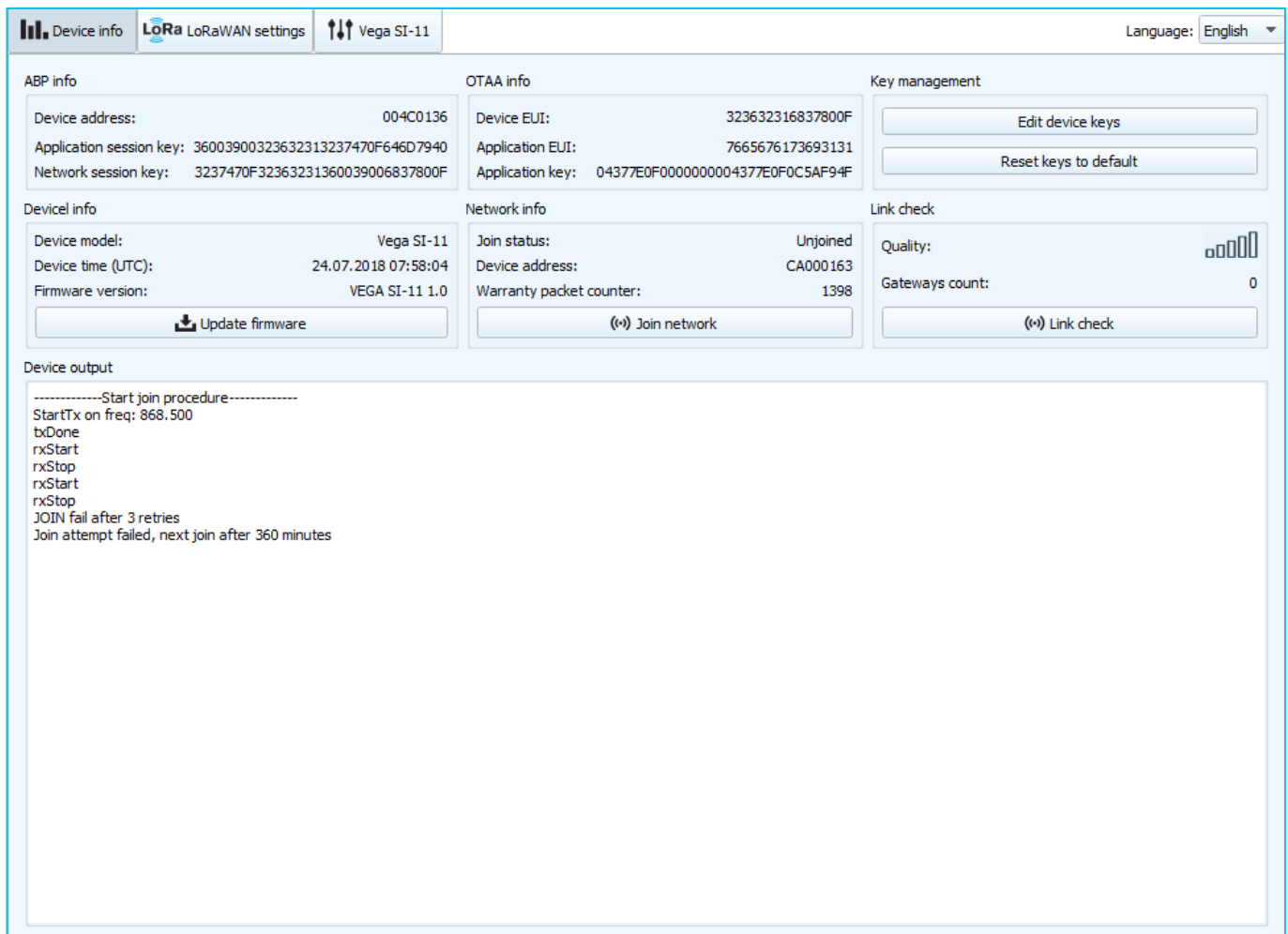

The screenshot shows the 'Device info' tab in the LoRaWAN configurator. The interface is divided into several sections:

- ABP info:** Device address: 004C0136; Application session key: 36003900323632313237470F646D7940; Network session key: 3237470F32363231360039006837800F.
- OTAA info:** Device EUI: 323632316837800F; Application EUI: 7665676173693131; Application key: 04377E0F000000004377E0F0C5AF94F.
- Key management:** Buttons for 'Edit device keys' and 'Reset keys to default'.
- Device info:** Device model: Vega SI-11; Device time (UTC): 24.07.2018 07:58:04; Firmware version: VEGA SI-11 1.0. Button: 'Update firmware'.
- Network info:** Join status: Unjoined; Device address: CA000163; Warranty packet counter: 1398. Button: 'Join network'.
- Link check:** Quality: (signal strength indicator); Gateways count: 0. Button: 'Link check'.
- Device output:** Log showing a failed join attempt: 'Start join procedure', 'StartTx on freq: 868.500', 'txDone', 'rxStart', 'rxStop', 'rxStart', 'rxStop', 'JOIN fail after 3 retries', 'Join attempt failed, next join after 360 minutes'.

**ABP info** - displays the data necessary to register the device in the LoRaWAN network with ABP method (Activation By Personalization).

**OTAA info** - the data required to register the device in the LoRaWAN network with OTAA method (Over The Air Activation) is displayed.

**Key management** (not displayed in the "Simple" mode) - allows you to change the factory keys to register the device on the network, and also reset the keys back to the factory settings.

**Device info** - the configurator reads information about the device model, its firmware and automatically corrects the device's time when connected to it.

**Update firmware** - allows you to select the firmware file from your computer's hard drive and load it into the device. The device will automatically disconnect from the configurator when the download is complete. The current version of the device firmware can be downloaded from [iotvega.com](http://iotvega.com).

**Network info** - shows whether the device is connected to the LoRaWAN network and its network address.

**Join network button** - launch the LoRaWAN network connection procedure with the previously selected ABP or OTAA method. If the device is already connected to the network, reconnection procedure will occur.

**Link check** (not displayed in the "Simple" mode) - when pressed, the device sends a special signal to the LoRaWAN network, in response to which the network informs it of the number of gateways that received this signal and the signal quality. This button only works when the device is connected to the network.

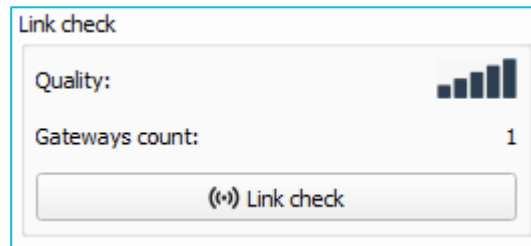

**Device output** (not displayed in the "Simple" mode) - monitoring the device status, all events in real time are displayed.

## "LORAWAN SETTINGS" TAB

The "LoRaWAN Settings" tab allows you to configure various parameters of the LoRa network.

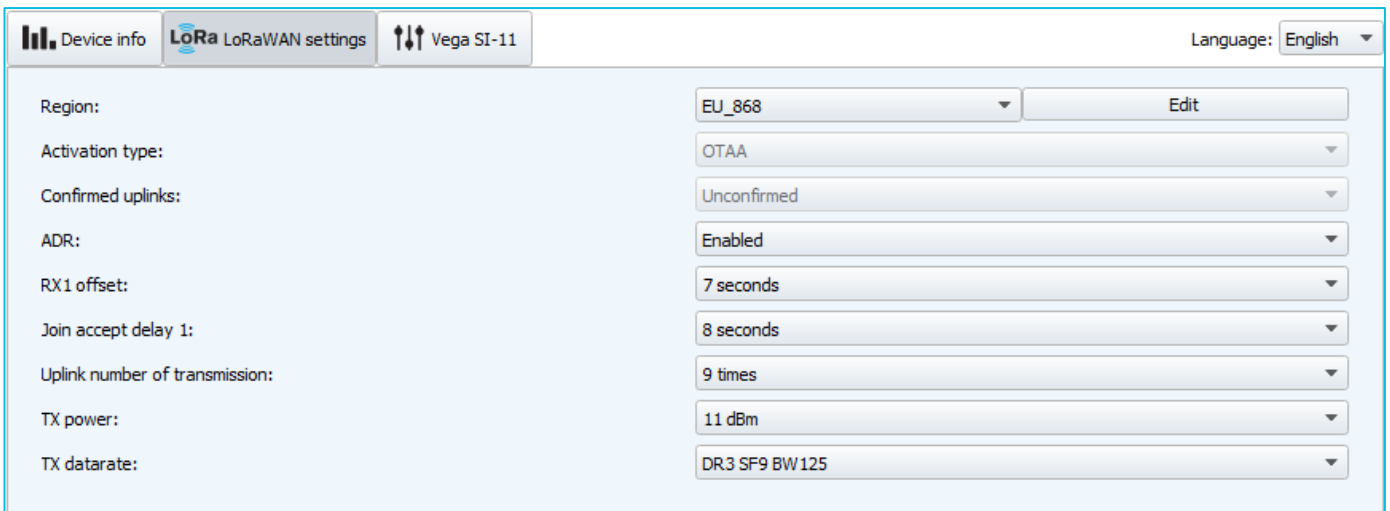

**Region** - allows you to select one of installed frequency plans or specify a custom frequency plan. Custom frequency plan is EU-868 based.

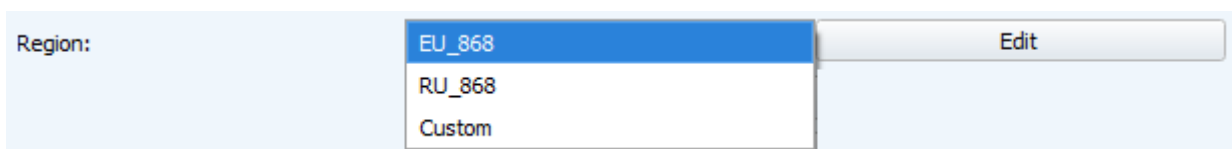



In device frequency plan, only those channels are active by default, on which sending requests for connection to the network (join channels). The remaining channels (that the device should use) can be transferring by the LoRaWAN network server during the device activation procedure (only OTAA).

If you select "Custom" in the "Region" field, you must manually specify the frequencies that the device will use. To do this, click the "Edit" button, the channel frequency editing window will appear:

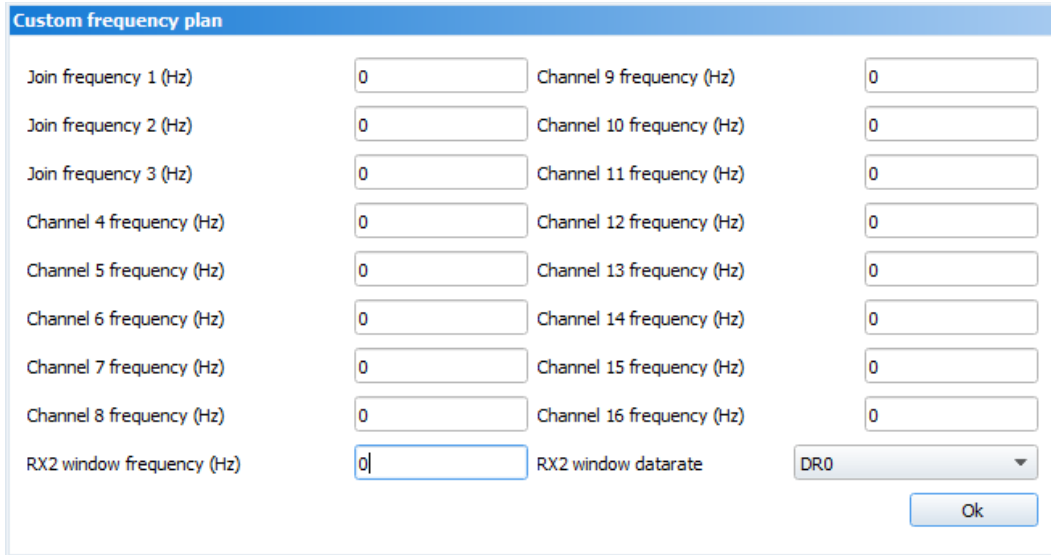

This frequency plan allows you to set up to 16 channels, as well as the frequency and speed of the second receiving window.



**The first three channels and the second receiving window parameters are mandatory. Without these parameters the custom frequency plan will be considered empty**

**Activation type** – allows to set up ABP or OTAA device activation method.

**Confirmed uplinks** – when you choose "confirmed", the device will retry sending the packet until it receives the server confirmation, or until the "Uplink number of transmission" is over (see below).



**If you choose to send a packet without confirmation, the modem will not know whether the packet is delivered or not**

**ADR** – this option activates the Adaptive Data Rate algorithm for automatic control of the data transfer rate from the LoRaWAN network server side. The higher the quality of the signal received by the network, the higher the speed will be installed on the device. This option is recommended only on permanently installed devices.

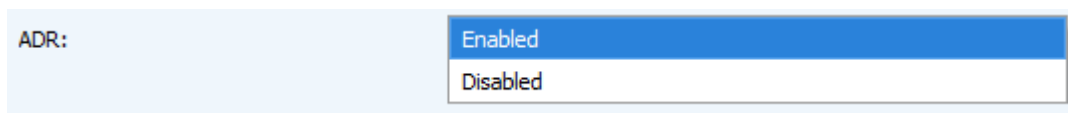

**RX1 offset** (not displayed in the "Simple" mode) – specifies the time between end of packet transmission and first receiving window opening. The second receiving window always opens after 1 second after the first.

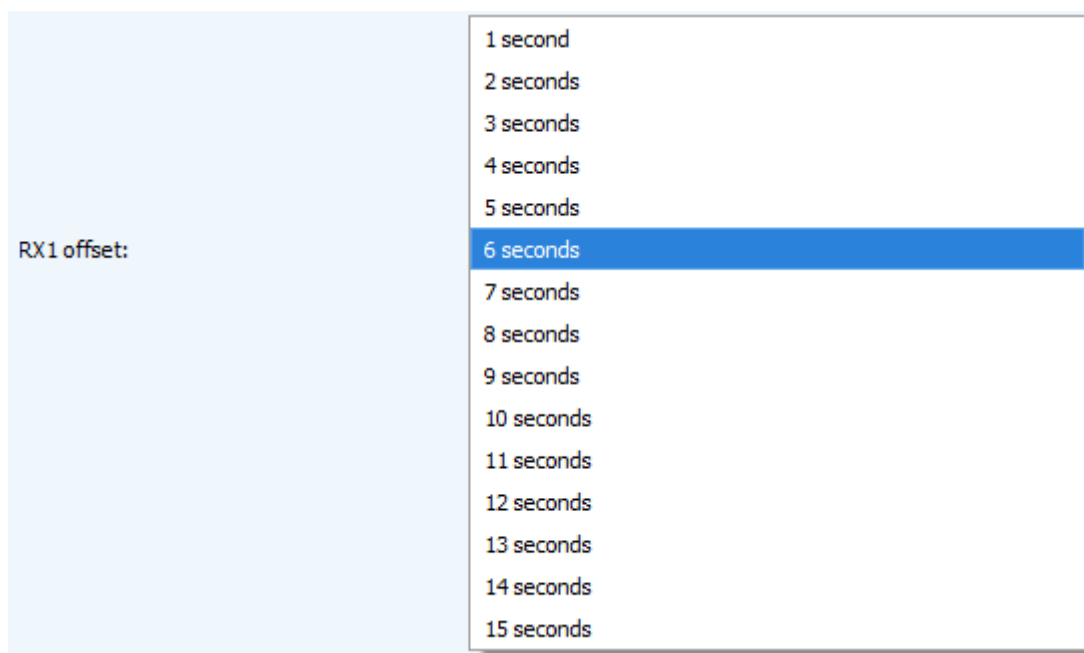

**Join accept delay 1** (not displayed in the "Simple" mode) – sets the time that the device will open the first receiving window to receive confirmation for the join request from the LoRaWAN network while OTAA mode active. The second window always opens after 1 second after the first.

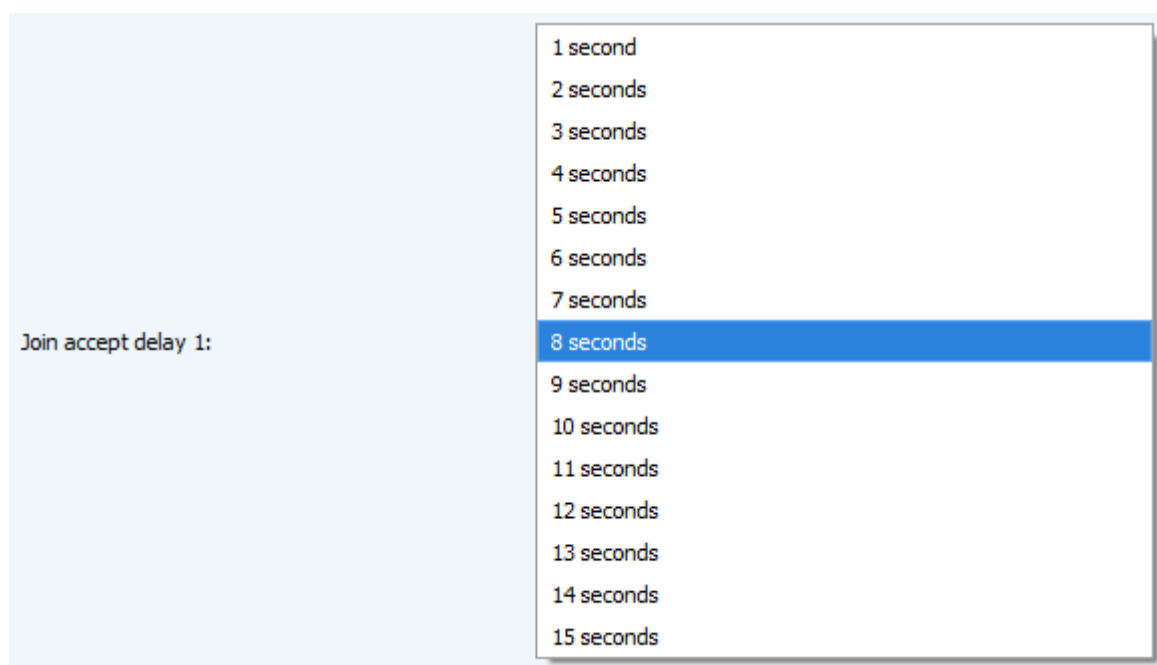

**Uplink number of transmission** (not displayed in the "Simple" mode) – if the "Confirmed uplinks" function is disabled, the device will simply send each packet as many times as specified in this option. If "Confirmed uplinks" is enabled, the device will send packets until it receives a confirmation or until it sends as many packets as specified in this option.

Uplink number of transmission:	<ul style="list-style-type: none"><li>1 time</li><li>2 times</li><li>3 times</li><li>4 times</li><li>5 times</li><li>6 times</li><li>7 times</li><li><b>8 times</b></li><li>9 times</li><li>10 times</li><li>11 times</li><li>12 times</li><li>13 times</li><li>14 times</li><li>15 times</li></ul>
--------------------------------	---

**TX power** (not displayed in the "Simple" mode) – the device RF transmitter power is adjusted to this value when sending packets to the LoRaWAN network. This option can be changed by the network server.

TX power:	<ul style="list-style-type: none"><li>2 dBm</li><li>5 dBm</li><li>8 dBm</li><li><b>11 dBm</b></li><li>14 dBm</li><li>20 dBm</li></ul>
-----------	---

**TX datarate** (not displayed in the "Simple" mode) – the device transmission datarate at which it will transfer packets to the LoRaWAN network. This speed can be changed by the network server if the ADR algorithm is enabled.

TX datarate:	<ul style="list-style-type: none"><li>DR0 SF12 BW125</li><li>DR1 SF11 BW125</li><li>DR2 SF10 BW125</li><li><b>DR3 SF9 BW125</b></li><li>DR4 SF8 BW125</li><li>DR5 SF7 BW125</li></ul>
--------------	---

## “VEGA SI-11” TAB

The “Vega SI-11” tab contains the settings of the connected device.

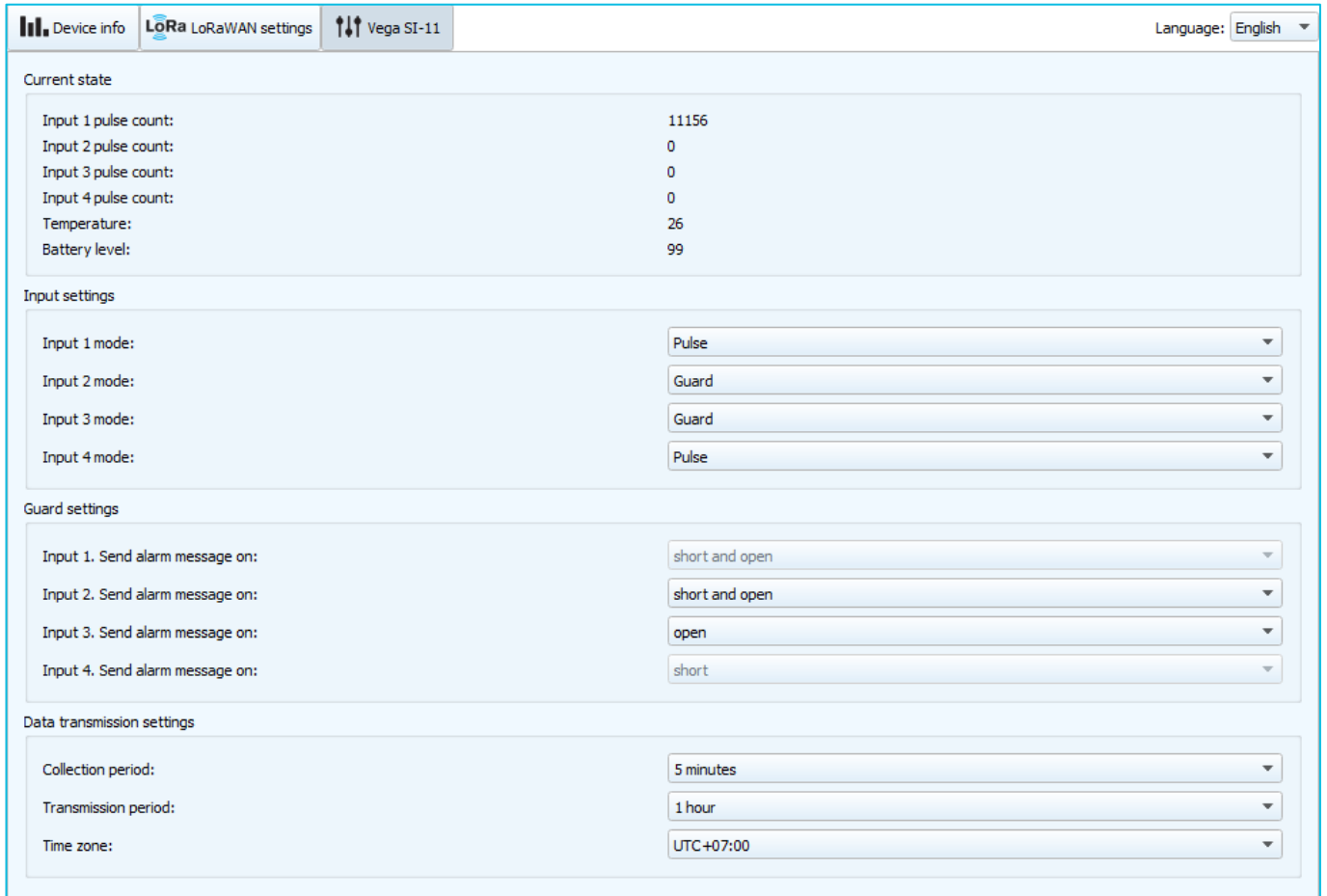

The screenshot shows the configuration interface for the Vega SI-11 device. It features a top navigation bar with tabs for 'Device info', 'LoRa LoRaWAN settings', and 'Vega SI-11'. A language dropdown is set to 'English'. The main content is divided into four sections:

- Current state:** A table showing real-time data:
 

Input 1 pulse count:	11156
Input 2 pulse count:	0
Input 3 pulse count:	0
Input 4 pulse count:	0
Temperature:	26
Battery level:	99
- Input settings:** Four dropdown menus for 'Input 1 mode' (Pulse), 'Input 2 mode' (Guard), 'Input 3 mode' (Guard), and 'Input 4 mode' (Pulse).
- Guard settings:** Four dropdown menus for 'Send alarm message on' for each input, with values: 'short and open', 'short and open', 'open', and 'short'.
- Data transmission settings:** Three dropdown menus for 'Collection period' (5 minutes), 'Transmission period' (1 hour), and 'Time zone' (UTC+07:00).

**Current state** – displays the current parameters of the device - the number of counted pulses at the inputs, the temperature and the battery level.

To reset the pulse count at the inputs, it is necessary to put the device in the "Storage" mode by pressing the button on the board for a long time (more than 5 seconds) (see section "Initial startup").

**Input settings** – allows to setting up the mode of inputs – pulse or guard. When transferring the input to the security mode, the device will send an alarm packet to the network (See part 5, packet 2) whenever this input triggers. The maximum possible frequency of sending alarm packets is one per 1 second.

**Guard settings** – allows setting up the work of security inputs, namely, what kind of security input state changing is reason to send an alarm message: short, open, or both of them.

**Data transmission settings** – a group of parameters that allows you to configure the collection and transmission periods, and the time zone for the internal clock of the counter will be set which.

The readings are read from the connected device at 00.00 on the internal clock of the device if the data collection period is set to 24 hours, at 00.00 and at 12.00, if the period is 12 hours and so on. All readings are stored in the device memory until the next communication session.

The data transfer period can be adjusted from 5 minutes to 24 hours. Data transfer is carried out by a random time at the selected period. At the next communication session, the device starts sending accumulated packets with readings, from the earliest to the latest.

With the "Confirmed uplinks" option turned on, the device will send the next packet only after receiving a confirmation of the delivery of the previous one. If such confirmation have not received after the fulfilled in the settings uplink number of transmission, device completes the communication session until the next one according to the schedule. In this case, the device continues to collect data according to the data collection period and store it in memory. Non-transmitted packets remain in the device memory until the next communication session.

With the "Confirmed uplinks" option turned off, the device just sends all accumulated packets to the network in order from the earliest to the latest. There are no checks of package delivery in this mode. There are no non-transmitted messages in the device memory.

## 5 COMMUNICATION PROTOCOL

This part describes the SI-11 communication protocol with LoRaWAN network.



**In fields consisting of several bytes, the little endian byte order is used**

### VEGA SI-11 PULSE COUNTER TRANSMITS THE FOLLOWING TYPES OF PACKETS

1. Packet with current readings, sent regularly on LoRaWAN port 2

Size in bytes	Field description	Data type
1 byte	Packet type, this packet == 1	uint8
1 byte	Battery charge, %	uint8
1 byte	Values of basic settings (bit field)	uint8
4 bytes	Reading time for values in this packet (unixtime UTC)	uint32
1 byte	Temperature, °C	int8
4 bytes	Input 1 reading (depending on the type – number of pulses or status: 0 – open, 1 - closed)	uint32
4 bytes	Input 2 reading (depending on the type – number of pulses or status: 0 – open, 1 - closed)	uint32
4 bytes	Input 3 reading (depending on the type – number of pulses or status: 0 – open, 1 - closed)	uint32
4 bytes	Input 4 reading (depending on the type – number of pulses or status: 0 – open, 1 - closed)	uint32

The counter has internal clock and calendar; time and date is factory set. When sending a packet with the current readings, the device uses the data taken at the nearest time, which is multiple to the interval according to data collection period:

- 1 hour period: the readings of the beginning of the current hour are sent;
- 6 hours period: 00:00, 06:00, 12:00, 18:00 readings are sent;
- 12 hours period: 00:00, 12:00 readings are sent;
- 24 hours period: the readings of 00:00 of the current day are sent.

### "Values of basic settings" bit field decoding

Bits	Field description
0 bit	Activation type: 0 - OTAA, 1 – ABP
1, 2,3 bits	Communication period:  1 == 0 2==0 3==0  - 5 minutes  1 == 1 2==0 3==0  - 15 minutes  1 == 0 2==1 3==0  - 30 minutes  1 == 1 2==1  3==0  - 1 hour  1 == 0 2==0 3==1  - 6 hours  1 == 1 2==0 3==1  - 12 hours  1 == 0 2==1 3==1  - 24 hours
4 bits	First input type: 0 – pulse, 1 - security
5 bits	Second input type: 0 – pulse, 1 - security
6 bits	Third input type: 0 – pulse, 1 - security
7 bits	Fourth input type: 0 – pulse, 1 - security

Time zone considered during collection data from an external meter.

### 2. «Alarm» packet sent in case of security input closure on LoRaWAN port 2

Size in bytes	Field description	Data type
1 byte	Packet type, this packet == 2	uint8
1 byte	Battery charge, %	uint8
1 byte	Values of basic settings (bit field)	uint8
1 byte	Input No, where the alarm is detected	uint8
4 bytes	Packet time (unixtime UTC)	uint32
4 bytes	Input 1 reading (depending on the type – number of pulses or status: 0 – open, 1 - closed)	uint32
4 bytes	Input 2 reading (depending on the type – number of pulses or status: 0 – open, 1 - closed)	uint32
4 bytes	Input 3 reading (depending on the type – number of pulses or status: 0 – open, 1 - closed)	uint32
4 bytes	Input 4 reading (depending on the type – number of pulses or status: 0 – open, 1 - closed)	uint32

When sending alarm packet, the device uses the data taken at moment of alarm triggers.

### 3. Packet with time correction request, sent every seven days on LoRaWAN port 4

Size in bytes	Field description	Data type
1 byte	Packet type, this packet == 255	uint8
4 bytes	Time of the modem at the moment of the packet transmission (unixtime UTC)	uint32

After receiving this type of package, the application can send to modem the packet with time correction.

4. Settings packet – transmitting on LoRaWAN port 3 when settings request command received or device connected to the network

Size in bytes	Field description	Data type
1 byte	Packet type, this packet == 0	uint8
2 bytes	ID of parameter	uint16
1 byte	Data length (len)	uint8
len bytes	Parameter value	-----
2 bytes	ID of parameter	uint16
1 byte	Data length (len)	uint8
len bytes	Parameter value	-----
...	...	...
2 bytes	ID of parameter	uint16
1 byte	Data length (len)	uint8
len bytes	Parameter value	-----



## VEGA SI-11 PULSE COUNTER RECEIVES PACKETS OF THE FOLLOWING TYPES

1. Real-time clock adjustment – send by application on LoRaWAN port 4

Size in bytes	Field description	Data type
1 byte	Packet type, this packet = 255	uint8
8 bytes	The value in seconds for which you need to adjust the time. Can be positive or negative	int64

2. Packet with request of settings – sent by application on LoRaWAN port 3

Size in bytes	Field description	Data type
1 byte	Packet type, this packet == 1	uint8

Answering this packet, the device sends the packet with settings.

3. Packet with settings is identical to such packet from device

Size in bytes	Field description	Data type
1 byte	Packet type, this packet == 0	uint8
2 bytes	ID of parameter	uint16
1 byte	Data length (len)	uint8
len bytes	Parameter value	-----
2 bytes	ID of parameter	uint16
1 byte	Data length (len)	uint8
len bytes	Parameter value	-----
...	...	...
2 bytes	ID of parameter	uint16
1 byte	Data length (len)	uint8
len bytes	Parameter value	-----

The package with settings sent to the device may not contain all the settings supported by the device, but only the part that needs to be changed.

Table of ID of SI-11 parameters and these possible values

ID of parameter	Description	Data length	Possible values
4	Confirmed uplinks	1 byte	1 – confirmed 2 – unconfirmed
8	Uplinks number of transmissions	1 byte	from 1 to 15
12	Input 1 mode	1 byte	1 – pulse 2 – guard
13	Input 2 mode	1 byte	1 – pulse 2 – guard

14	Input 3 mode	1 byte	1 – pulse 2 – guard
15	Input 4 mode	1 byte	1 – pulse 2 – guard
16	Communication period	1 byte	1 – 1 hour 2 – 6 hours 3 – 12 hours 4 – 24 hours 5 – 5 minutes 6 – 15 minutes 7 – 30 minutes
49	Data collection period	1 byte	1 – 1 hour 2 – 6 hours 3 – 12 hours 4 – 24 hours 5 – 5 minutes 6 – 15 minutes 7 – 30 minutes
55	Time zone, in minutes	2 bytes	from -720 to 840

## 6 STORAGE AND TRANSPORTATION REQUIREMENTS

Vega SI-11 pulse counter shall be stored in the original packaging in heated room at temperatures  $+5^{\circ}\text{C}$  to  $+40^{\circ}\text{C}$  and relative humidity less than 85%.

The counter shall be transported in covered freight compartments of all types at any distance at temperatures  $-40^{\circ}\text{C}$  to  $+85^{\circ}\text{C}$ .

## 7 CONTENT OF THE PACKAGE

The pulse counter is delivered complete with:

Vega SI-11 pulse counter – 1 pc.

Screw – 4 pcs.

Factory certificate – 1 pc.

## 8 WARRANTY

The warranty period for the device is 5 years from the date of sale.

The manufacturer is obligated to provide repair services or replace the failed device during the entire warranty period.

The consumer is obliged to comply with the conditions and rules of transportation, storage and operation specified in this user manual.

Warranty does not apply to:

- power supplies of devices sending more than 80,000 packets;
- the device with mechanical, electrical and / or other damages and defects caused by violation of the transportation, storage and operation requirements;
- the device with traces of repair performed not by the manufacturer's service center;
- the device with traces of oxidation or other signs of liquids leaking inside the device.

In the event of a warranty claim, contact the service center:

113/1, Kirova Str., Novosibirsk, 630008, Russia.

Tel.: +7 (383) 206-41-35.



[vega-absolute.ru](http://vega-absolute.ru)

User Manual © Vega-Absolute OOO 2017-2020